

CATÁLOGO 2022

I l u m i n a c i ó n L E D

WINLED
Más que Iluminación

artlite
ILUMINACIÓN LED





ADO-001

ADO-009

7.3cm
DIÁMETRO EMPOTRAMIENTO

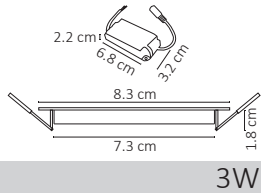

3W

ADO-002

ADO-010

10.6cm
DIÁMETRO EMPOTRAMIENTO

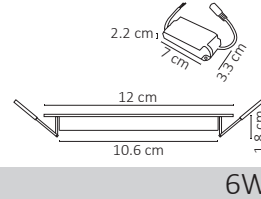

6W

ADO-015

ADO-016

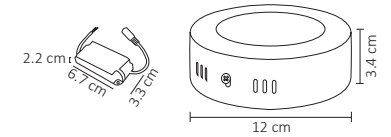

6W



ADO-003

ADO-008

15.7cm
DIÁMETRO EMPOTRAMIENTO

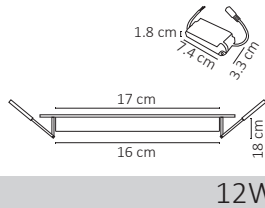

12W

ADO-004

ADO-012

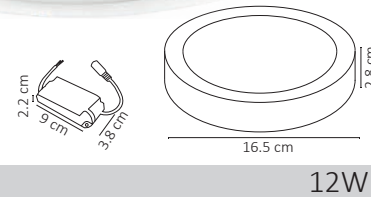

12W

ADO-018

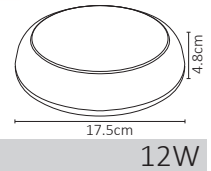

12W

#	💡	W	⚡	☀️	360°	🌈	↔️	💎	💧	🔍
Código	Producto	Watts	Voltaje	Lúmenes	Apertura	Temp. Color	Dimensiones	Material	Protección	Observaciones
ADO-001	Pánel LED Redondo Slim Blanco Frío	3W	90-277V~50/60Hz	250LM	120°	6500K	D. 83x18mm	Lámina + Policarbonato	IP20	Incluye Driver/Diam. Emp. 8cm
ADO-009	Pánel LED Redondo Slim Blanco Cálido	3W	90-277V~50/60Hz	230LM	120°	3000K	D. 83x18mm	Lámina + Policarbonato	IP20	Incluye Driver/Diam. Emp. 8cm
ADO-002	Pánel LED Redondo Slim Blanco Frío	6W	90-277V~50/60Hz	500LM	120°	6500K	D. 120x18mm	Lámina + Policarbonato	IP20	Incluye Driver/Diam. Emp. 10.6cm
ADO-010	Pánel LED Redondo Slim Blanco Cálido	6W	90-277V~50/60Hz	450LM	120°	3000K	D. 120x18mm	Lámina + Policarbonato	IP20	Incluye Driver/Diam. Emp. 10.6cm
ADO-015	Pánel LED Redondo Sobreponer Blanco Frío	6W	90-277V~50/60Hz	500LM	120°	6500K	D. 120x34mm	Lámina + Policarbonato	IP20	Incluye Driver
ADO-016	Pánel LED Redondo Sobreponer Blanco Cálido	6W	90-277V~50/60Hz	450LM	120°	3000K	D. 120x34mm	Lámina + Policarbonato	IP20	Incluye Driver
ADO-003	Pánel LED Redondo Slim Blanco Frío	12W	90-277V~50/60Hz	1,000LM	120°	6500K	D. 170x18mm	Lámina + Policarbonato	IP20	Incluye Driver/Diam. Emp. 15.7cm
ADO-008	Pánel LED Redondo Slim Blanco Cálido	12W	90-277V~50/60Hz	950LM	120°	3000K	D. 170x18mm	Lámina + Policarbonato	IP20	Incluye Driver/Diam. Emp. 15.7cm
ADO-004	Pánel LED Redondo Sobreponer Blanco Frío	12W	90-277V~50/60Hz	1,000LM	120°	6500K	D. 162x28mm	Lámina + Policarbonato	IP20	Incluye Driver
ADO-012	Pánel LED Redondo Sobreponer Blanco Cálido	12W	90-277V~50/60Hz	950LM	120°	3000K	D. 162x28mm	Lámina + Policarbonato	IP20	Incluye Driver
ADO-018	Pánel LED Redondo Sobreponer Blanco Frío	12W	100-277V~50/60Hz	960LM	120°	6500K	D. 175x48mm	Plástico + Policarbonato	IP65	Incluye Driver/A Prueba de Vapor



ADO-005
ADO-011

21cm
DIÁMETRO
(EMPOTRAMIENTO)

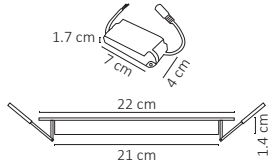

18W



ADO-013
ADO-014

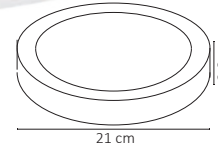

18W



ADO-019
ADO-020

28cm
DIÁMETRO
(EMPOTRAMIENTO)

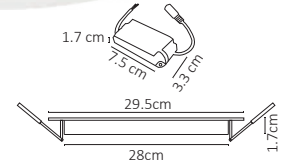

24W



ADO-017

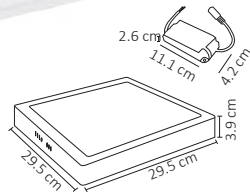

24W

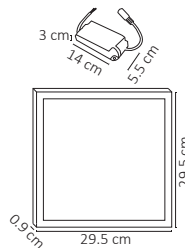

ADO-006

25W

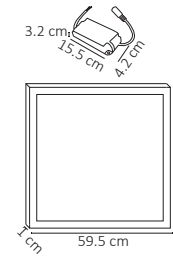

ADO-007

40W

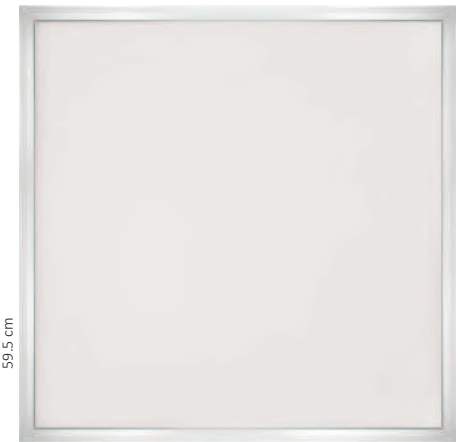

Código	Producto	Watts	Voltaje	Lúmenes	Apertura	Temp. Color	Dimensiones	Material	Protección	Observaciones
ADO-005	Pánel LED Redondo Slim Blanco Frío	18W	90-277V~50/60Hz	1,500LM	120°	6500K	D. 220x18mm	Lámina + Policarbonato	IP20	Incluye Driver/Diam. Emp. 21.5cm
ADO-011	Pánel LED Redondo Slim Blanco Cálido	18W	90-277V~50/60Hz	1,450LM	120°	3000K	D. 220x18mm	Lámina + Policarbonato	IP20	Incluye Driver/Diam. Emp. 21.5cm
ADO-013	Pánel LED Redondo Blanco Frío	18W	90-277V~50/60Hz	1,500LM	120°	6500K	D. 210x28mm	Lámina + Policarbonato	IP20	Incluye Driver
ADO-014	Pánel LED Redondo Blanco Cálido	18W	90-277V~50/60Hz	1,450LM	120°	3000K	D. 210x28mm	Lámina + Policarbonato	IP20	Incluye Driver
ADO-019	Pánel LED Redondo Slim Blanco Frío	24W	90-277V~50/60Hz	2,000LM	120°	6500K	D. 295x17mm	Lámina + Policarbonato	IP20	Incluye Driver/Diam. Emp. 28cm
ADO-020	Pánel LED Redondo Slim Blanco Cálido	24W	90-277V~50/60Hz	1,950LM	120°	3000K	D. 295x17mm	Lámina + Policarbonato	IP20	Incluye Driver/Diam. Emp. 28cm
ADO-017	Pánel LED Cuadrado Sobreponer Blanco Frío	24W	90-277V~50/60Hz	1,800LM	120°	6500K	295x295x39mm	Lámina + Policarbonato	IP20	Incluye Driver
ADO-006	Pánel LED Cuadrado Slim Blanco Frío 30cm	25W	90-277V~50/60Hz	2,000LM	120°	6500K	295x295x9mm	Aluminio + Policarbonato	IP20	Incluye Driver y Sujetadores
ADO-007	Pánel LED Cuadrado Slim Blanco Frío 60cm	40W	90-277V~50/60Hz	3,400LM	120°	6500K	595x595x10mm	Aluminio + Policarbonato	IP20	Incluye Driver y Sujetadores

DISPONIBLES
JUNIO
2022

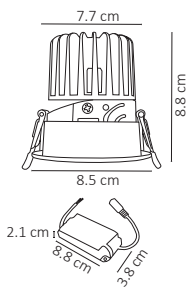

ADO-021

ADO-022

7.7cm
DIÁMETRO
EMPOTRAMIENTO



12W

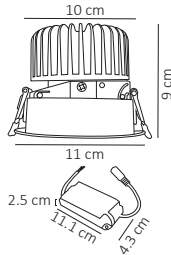

ADO-023

ADO-024

10cm
DIÁMETRO
EMPOTRAMIENTO



20W

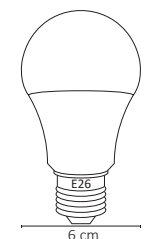

ALA-017

ALA-018



12W

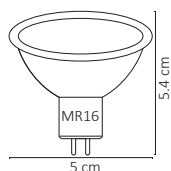

ALA-001

ALA-002



5W

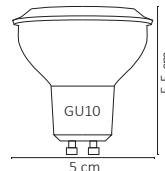

ALA-006

ALA-007



7W

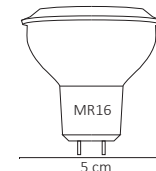

ALA-014

ALA-015



7W

#	💡	W	⚡	☀️	360°	🌈	↔️	💎	💧	🔍
Código	Producto	Watts	Voltaje	Lúmenes	Apertura	Temp. Color	Dimensiones	Material	Protección	Observaciones
ADO-021	Empotrable LED Dirigible Profesional BF	12W	90-277V~50/60Hz	960LM	24°	6500K	D. 85x88mm	Aluminio + PC	IP20	Incluye Driver/Diam. Emp. 7.7cm
ADO-022	Empotrable LED Dirigible Profesional BC	12W	90-277V~50/60Hz	900LM	24°	3000K	D. 85x88mm	Aluminio + PC	IP20	Incluye Driver/Diam. Emp. 7.7cm
ADO-023	Empotrable LED Dirigible Profesional BF	20W	90-277V~50/60Hz	1,600LM	24°	6500K	D. 110x90mm	Aluminio + PC	IP20	Incluye Driver/Diam. Emp. 10cm
ADO-024	Empotrable LED Dirigible Profesional BC	20W	90-277V~50/60Hz	1,550LM	24°	3000K	D. 110x90mm	Aluminio + PC	IP20	Incluye Driver/Diam. Emp. 10cm
ALA-017	Lámpara LED Bulbo E26 Blanco Frío	12W	100-140V~50/60Hz	1,200LM	220°	6500K	D. 60x110mm	Plástico + Policarbonato	IP20	E26
ALA-018	Lámpara LED Bulbo E26 Blanco Cálido	12W	100-140V~50/60Hz	1,100LM	220°	3000K	D. 60x110mm	Plástico + Policarbonato	IP20	E26
ALA-001	Lámpara LED Spot MR16 Blanco Frío	5W	90-260V~50/60Hz	430LM	120°	6500K	D. 50x54mm	Cerámica + Vidrio	IP20	MR16
ALA-002	Lámpara LED Spot MR16 Blanco Cálido	5W	90-260V~50/60Hz	400LM	120°	3000K	D. 50x54mm	Cerámica + Vidrio	IP20	MR16
ALA-006	Lámpara LED Spot GU10 Blanco Frío	7W	90-260V~50/60Hz	580LM	45°	6500K	D. 50x55mm	Plástico + Policarbonato	IP20	GU10
ALA-007	Lámpara LED Spot GU10 Blanco Cálido	7W	90-260V~50/60Hz	550LM	45°	3000K	D. 50x55mm	Plástico + Policarbonato	IP20	GU10
ALA-014	Lámpara LED Spot MR16 Blanco Frío	7W	90-260V~50/60Hz	580LM	45°	6500K	D. 50x55mm	Plástico + Policarbonato	IP20	MR16
ALA-015	Lámpara LED Spot MR16 Blanco Cálido	7W	90-260V~50/60Hz	550LM	45°	3000K	D. 50x55mm	Plástico + Policarbonato	IP20	MR16

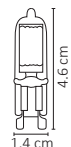

ALA-026

2W

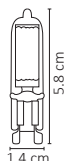

ALA-027

4W

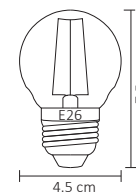

ALA-023

2W

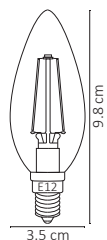

ALA-005

4W

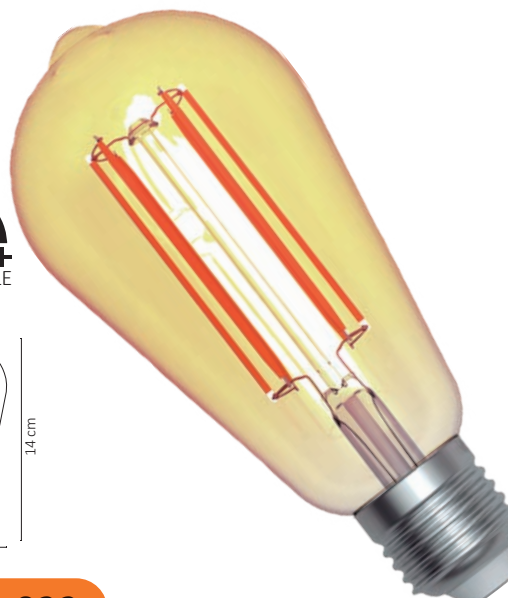
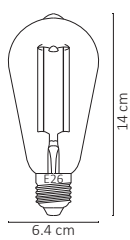

ALA-022

4W

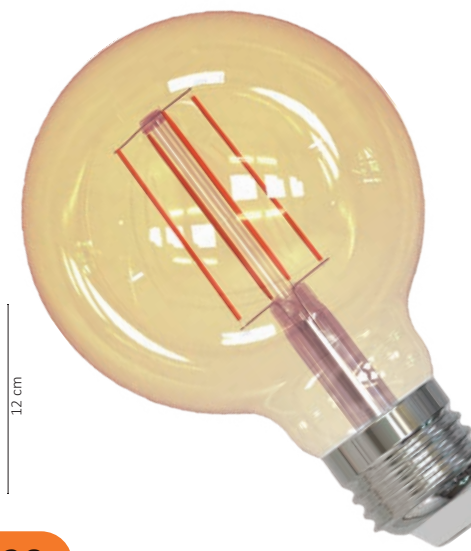
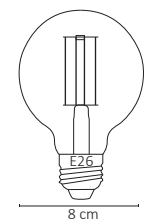

ALA-028

7W

#	💡	W	⚡	☀️	360°	🌈	↔️	💎	💧	🔍
Código	Producto	Watts	Voltaje	Lúmenes	Apertura	Temp. Color	Dimensiones	Material	Protección	Observaciones
ALA-026	Lámpara LED G9 2W Ambar	2W	100-140V~50/60Hz	150LM	320°	1800K	D. 14x50mm	Vidrio	IP20	G9
ALA-027	Lámpara LED G9 4W Ambar	4W	100-140V~50/60Hz	300LM	320°	1800K	D. 15x60mm	Vidrio	IP20	G9
ALA-023	Lámpara LED Filamento E26 2W G45 Ambar	2W	100-140V~50/60Hz	180LM	320°	1800K	D. 45x75mm	Lámina + Vidrio	IP20	E26
ALA-005	Lámpara Vela E12 Filamento Blanco Cálido	4W	100-140V~50/60Hz	400LM	320°	2700K	D. 35x98mm	Lámina + Vidrio	IP20	E12 - Dimeable
ALA-022	Lámpara LED Filamento E26 4W ST64 Ambar	4W	100-140V~50/60Hz	360LM	320°	1800K	D. 64x140mm	Lámina + Vidrio	IP20	E26 - Dimeable
ALA-028	Lámpara LED de Filamento E26 7W Ambar	7W	100-140V 50/60Hz	700LM	320°	1800K	D. 80x120mm	Lámina + Vidrio	IP20	E26 - Dimeable

LÁMPARA LED AJUSTABLE INDUSTRIAL 100W



Rotación Individual

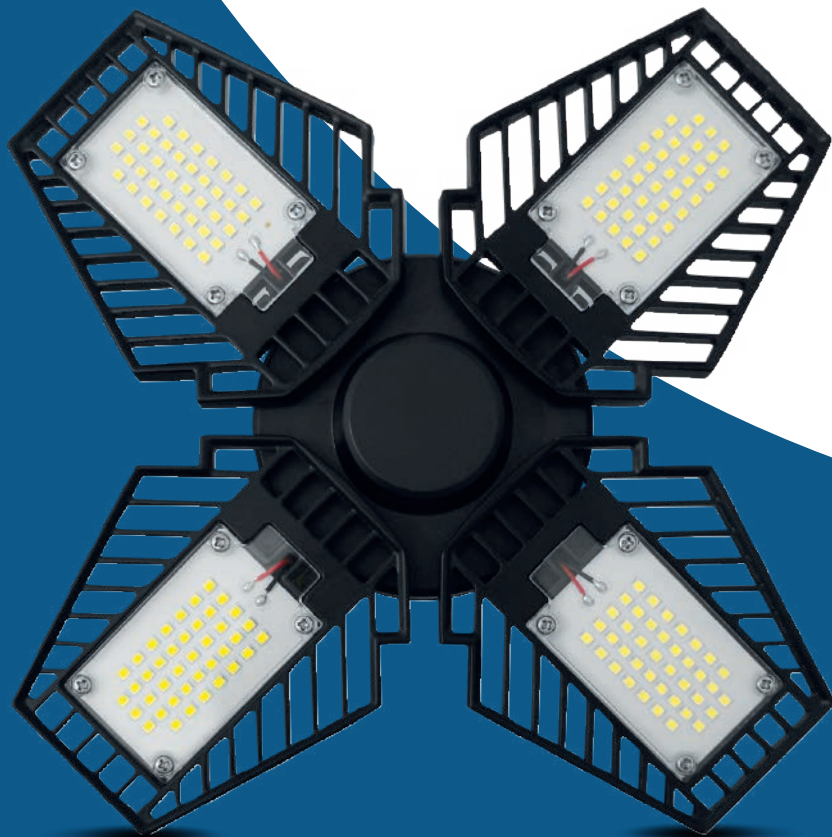

ALA-031

Potencia: 100W

Lúmenes: 10,000 Lm

Voltaje: 100-277V~50/60Hz

Temperatura de Color: 6500K Blanco Frío

Diámetro de Apertura: 120° a 270°

Material: Policarbonato + Plástico

Dimensiones: 335x115mm

IP: 20

Tipo de LED: 160 Pzs. SMD 2835

IRC: >80

Garantía: 3 años

artlite
ILUMINACIÓN LED

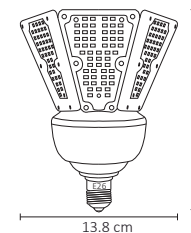
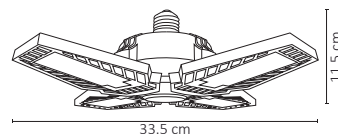

ALA-024 / ALA-025

Potencia: 50W

Voltaje: 90-300V~50/60Hz

Diámetro de Apertura: 120°

Material: Aluminio + Plástico

Dimensiones: 138x190mm

IP: 65

Tipo de LED: SMD

IRC: >80

Garantía: 3 años

BC

BF

6,000
Lúmenes

6,500
Lúmenes

3000K
Blanco Cálido

6500K
Blanco Frío



*Ejemplo de Instalación Punta Poste.



Rotación Individual
90°

Plástico + Aluminio
MATERIAL

**6500K
BLANCO FRÍO**



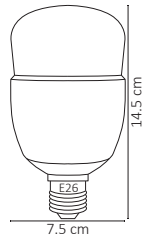

ALA-019



30W

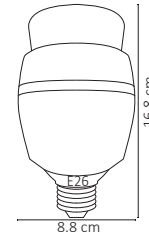

ALA-013



70W

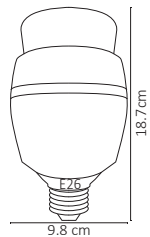

ALA-016



100W

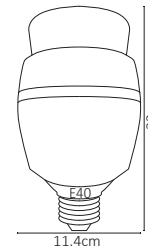

ALA-020



150W

#	💡	Ⓜ	⚡	☀️	360°	🌈	↔️	💎	💧	🔍
Código	Producto	Watts	Voltaje	Lúmenes	Apertura	Temp. Color	Dimensiones	Material	Protección	Observaciones
ALA-019	Lámpara LED Industrial E26 Blanco Frío	30W	90-300V~50/60Hz	3,000LM	120°	6500K	75x145mm	Aluminio + Vidrio + PC	IP20	Base E26
ALA-013	Lámpara LED Industrial E26 Blanco Frío	70W	90-300V~50/60Hz	7,000LM	120°	6500K	88x168mm	PC + Alum. + Plástico	IP20	E26/Ventilador para Disipar Calor
ALA-016	Lámpara LED Industrial E26 Blanco Frío	100W	90-300V~50/60Hz	10,000LM	120°	6500K	98x187mm	PC + Alum. + Plástico	IP20	E26/Ventilador para Disipar Calor
ALA-020	Lámpara LED Industrial E40 Blanco Frío	150W	90-300V~50/60Hz	15,000LM	120°	6500K	115x230mm	PC + Alum. + Plástico	IP20	E40/Ventilador para Disipar Calor

*No instalar en campanas cerradas.

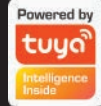

SMART



Descarga App Smart Life



Regístrate



Agrega los productos



Controla

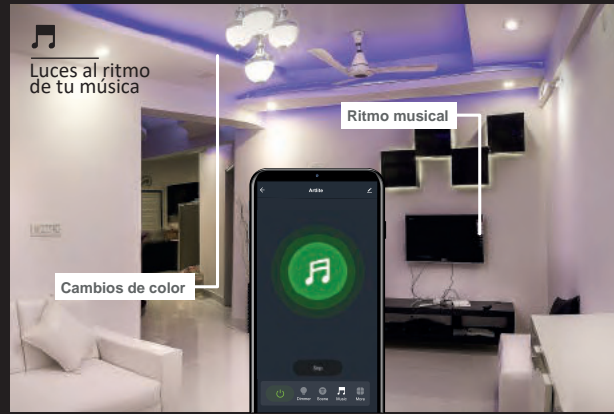
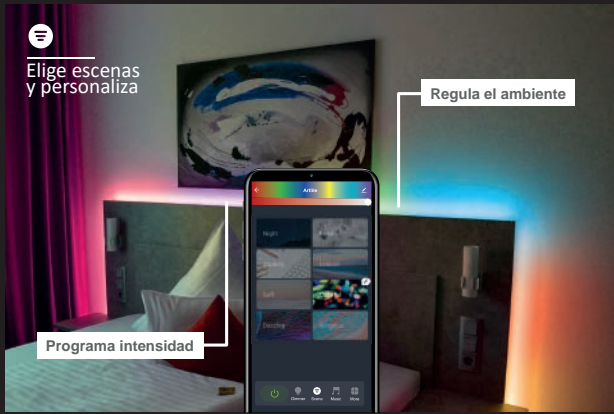
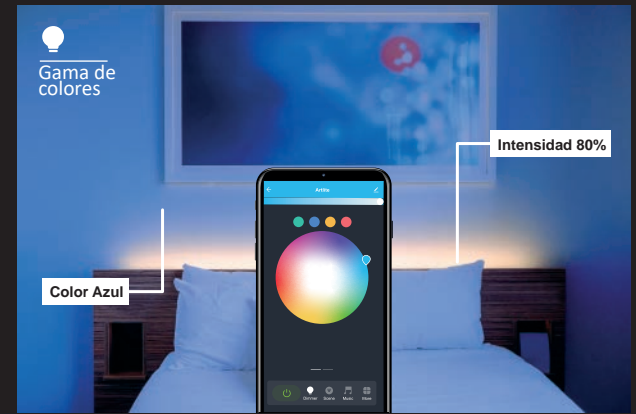
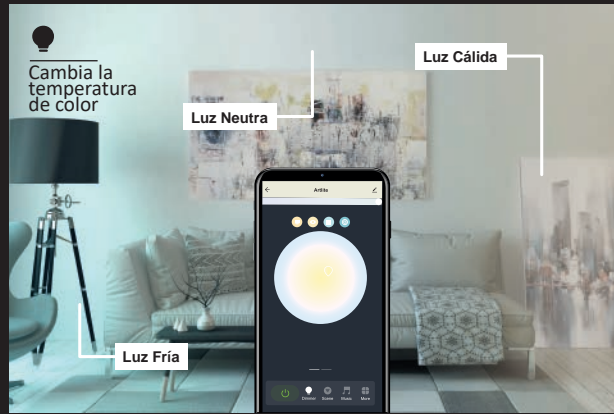
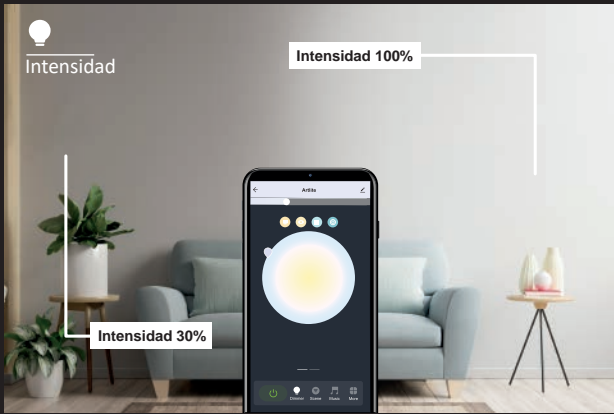

Conéctanos con:

amazon alexa

Google Assistant

artlite
ILUMINACIÓN LED





ALA-029

LÁMPARA LED SMART
WIFI Y BLUETOOTH E26 10W
RGB CW MULTICOLOR Y
BLANCOS ATENUABLES

BULBO	10 WATTS	MÁX. 850 LÚMENES
RGB CW MULTICOLOR Y BLANCOS ATENUABLES	110-130V~ 50/60Hz ENTRADA	E26 BASE
PROTECCIÓN IP20 INTERIOR	- SI + ATENUABLE	60x119 mm DIMENSIONES
OMNIDIRECCIONAL	180°	PLÁSTICO MATERIAL

Duo Pack



ASM-001

TIRA LED SMART RGB CW
COLORES Y BLANCOS
DINAMICOS WIFI BLUETOOTH
C/DRIVER

TIRA LED	24 WATTS	MÁX. 1,300 LÚMENES
RGB CW MULTICOLOR Y BLANCOS ATENUABLES	100-240V~ 50/60Hz ENTRADA	INCLUYE CONTROLADOR Y DRIVER
PROTECCIÓN IP65 EXTERIOR	- SI + ATENUABLE	5000 x 12mm DIMENSIONES
OMNIDIRECCIONAL	120°	CUBIERTA DE SILICON MATERIAL

*Incluye 1 controlador y 1 driver.



ALA-030

LÁMPARA LED SMART
WIFI Y BLUETOOTH GU10 6W
RGB CW MULTICOLOR Y
BLANCOS ATENUABLES

SPOT	6 WATTS	MÁX. 400 LÚMENES
RGB CW MULTICOLOR Y BLANCOS ATENUABLES	110-130V~ 50/60Hz ENTRADA	GU10 BASE
PROTECCIÓN IP20 INTERIOR	- SI + ATENUABLE	50x55 mm DIMENSIONES
DIRECCIONAL	105°	PLÁSTICO MATERIAL

Duo Pack



ASM-002

ENCHUFE SMART REDONDO
BLANCO WIFI BLUETOOTH
MÁX. 1875W

ENCHUFE	MÁX. 1875 WATTS	90-260V~ 50/60Hz ENTRADA
MÁXIMO 15A CORRIENTE @125V~	POLICAR- BONATO MATERIAL	50.6x52 mm DIMENSIONES
PROTECCIÓN IP20 INTERIOR		



EN CONDICIONES
NORMALES*

*APP disponible para sistemas IOS y ANDROID.

*Requiere conexión a internet mediante red Wi-Fi 2.4 Ghz.

*Compatible con comando de voz: Google Assistant y Amazon Alexa.



ATU-001

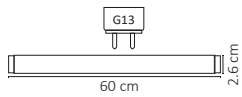

10W



ATU-002

ATU-003

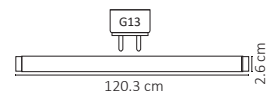

18W



ATU-004

ATU-005

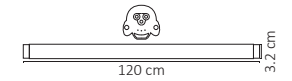

18W



T5

ATU-010

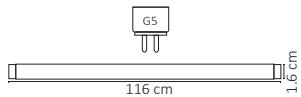

18W



ATU-007

ATU-008

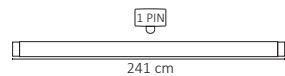

36W

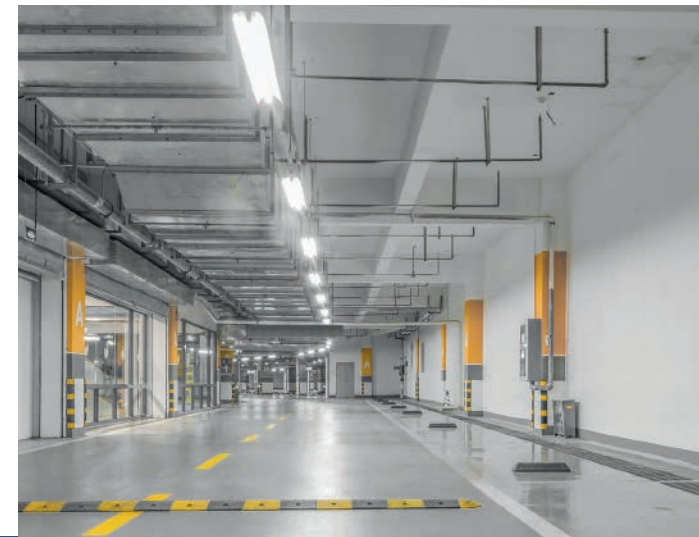

Código	Producto	Watts	Voltaje	Lúmenes	Apertura	Temp. Color	Dimensiones	Material	Protección	Observaciones
ATU-001	Tubo LED T8 Opalino Blanco Frío	10W	90-260V~50/60Hz	950LM	150°	6500K	600x26mm	Plástico + Vidrio	IP20	Conexión 2 Polos
ATU-002	Tubo LED T8 Transparente Blanco Frío	18W	90-260V~50/60Hz	2,000LM	120°	6500K	1203x26mm	Plástico + Vidrio	IP20	Conexión 2 Polos
ATU-003	Tubo LED T8 Opalino Blanco Frío	18W	90-260V~50/60Hz	1,900LM	150°	6500K	1203x26mm	Plástico + Vidrio	IP20	Conexión 2 Polos
ATU-004	Tubo LED T8 con Base Transparente Blanco Frío	18W	90-260V~50/60Hz	2,000LM	120°	6500K	1200x32mm	Plástico	IP20	Hasta 5 Interconexiones
ATU-005	Tubo LED T8 con Base Opanilo Blanco Frío	18W	90-260V~50/60Hz	1,900LM	150°	6500K	1200x32mm	Plástico	IP20	Hasta 5 Interconexiones
ATU-010	Tubo LED T5 Transparente	18W	100-265V~50/60Hz	2,000LM	150°	6500K	1160x16mm	Plástico + Vidrio	IP20	Conexión 2 Polos
ATU-007	Tubo LED T8 -1 PIN- Transparente Blanco Frío	36W	90-260V~50/60Hz	4,000LM	120°	6500K	2410x26mm	Plástico + Aluminio	IP20	Conexión 2 Polos
ATU-008	Tubo T8 -1 PIN- Opalino Blanco Frío	36W	90-260V~50/60Hz	3,800LM	150°	6500K	2410x26mm	Plástico + Aluminio	IP20	Conexión 2 Polos



AGA-007

2xG13



AGA-008

36W



AGA-006



40W



Proyectos Solares

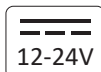

12-24V



Proyectos Solares

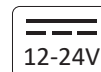

12-24V

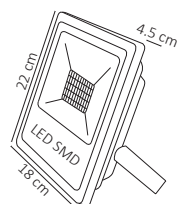

ARE-013

30W

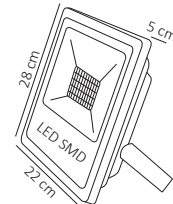

ARE-014

50W



ARE-016

28W



ACO-001

#	💡	W	⚡	☀️	360°	🌈	↔️	💎	💧	🔍
Código	Producto	Watts	Voltaje	Lúmenes	Apertura	Temp. Color	Dimensiones	Material	Protección	Observaciones
AGA-007	Gabinete Industrial a Prueba de Vapor Slim para Dos Tubos T8	2x18W	90-260V~50/60Hz	-	120°	-	1,270x105x60mm	Polycarbonato	IP65	No Incluye Tubos
AGA-008	Gabinete Slim Sobreponer LED Integrado Tipo Regleta Blanco Frío	36W	90-260V~50/60Hz	3,600LM	120°	6500K	1,200x77x25mm	Plástico	IP20	LED Integrado
AGA-006	Gabinete Industrial LED Integrado a Prueba de Vapor IP65 Blanco Frío	40W	90-260V~50/60Hz	4,000LM	120°	6500K	1,170x53x38mm	Plástico	IP65	A Prueba de Vapor
ARE-013	Reflector LED SMD Cuadrado Slim Blanco Frío	30W	12-24V==	2,850LM	120°	6500K	180x220x45mm	Aluminio + Vidrio	IP66	Para Proyectos Solares
ARE-014	Reflector LED SMD Cuadrado Slim Blanco Frío	50W	12-24V==	4,650LM	120°	6500K	220x280x50mm	Aluminio + Vidrio	IP66	Para Proyectos Solares
ARE-016	Luminaria para Muro Blanco Frío	28W	100-260V~50/60Hz	2,500LM	120°	6500K	335x118x54.6mm	Aluminio + Plástico	IP65	Para Muro
ACO-001	Brazo Complemento para ARE-016	-	-	-	-	-	91x64.7x25mm	Metal	IP65	Complemento ARE-016

LUMINARIA PARA CALLE BLANCO FRÍO 60W

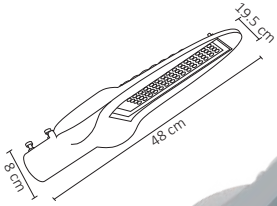

BF

arLite
ILUMINACIÓN LED

BF

5700K
Blanco Frío

5700K
Blanco Frío

ARE-019

Potencia: 60W
Lúmenes: 7,500 Lm
Voltaje: 90-277V~50/60Hz
Diámetro de Apertura: 140°
Material: Aluminio + Plástico
Dimensiones: 480x195x80mm
IP: 66
Tipo de LED: SMD 2835

ARE-020

Potencia: 100W
Lúmenes: 12,500 Lm
Voltaje: 90-277V~50/60Hz
Diámetro de Apertura: 150°
Material: Aluminio + Plástico
Dimensiones: 567x233x90mm
IP: 66
Tipo de LED: SMD 2835

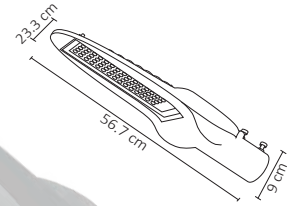

LUMINARIO WALLPACK PARA PARED 80W

Potencia: 80W
Lúmenes: 10,000 Lm
Voltaje: 90-277V~50/60Hz
Apertura: 80x105°
Material: Aluminio + Vidrio
Dimen.: 320x172x130mm
IP: 66
LED: SMD 2835

6500K
Blanco Frío

BF

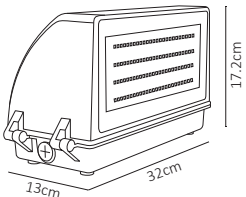

ARE-021



LUMINARIO 100W PUNTA POSTE

ARE-024

Potencia: 100W
Lúmenes: 12,000Lm
Voltaje: 90-277V~50/60Hz
Apertura: 120°
Material: Aluminio + Vidrio
Dimen.: 466x565mm
IP: 66
LED: SMD 2835

5700K
Blanco Frío

BF

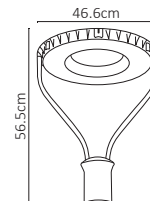

DISPONIBLE
JUNIO
2022

Reflectores LED

110
LM/W
EFICIENCIA

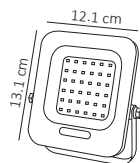

ARE-001

ARE-002

20W

110
LM/W
EFICIENCIA

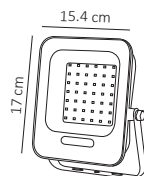

ARE-003

ARE-004

30W

110
LM/W
EFICIENCIA

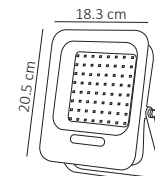

ARE-005

ARE-006

50W

110
LM/W
EFICIENCIA

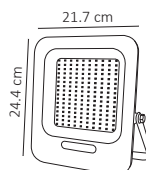

ARE-007

100W

110
LM/W
EFICIENCIA

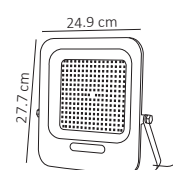

ARE-011

150W

110
LM/W
EFICIENCIA

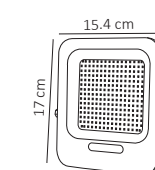

ARE-017

200W

#	💡	W	⚡	☀️	360°	🌈	↔️	💎	💧	🔍
Código	Producto	Watts	Voltaje	Lúmenes	Apertura	Temp. Color	Dimensiones	Material	Protección	Observaciones
ARE-001	Reflector LED SMD Cuadrado Slim Blanco Frío	20W	90-277V~50/60Hz	2,200LM	120°	6500K	121x131x23mm	Aluminio + Vidrio	IP66	Fácil Instalación
ARE-002	Reflector LED SMD Cuadrado Slim Blanco Cálido	20W	90-277V~50/60Hz	2,100LM	120°	3000K	121x131x23mm	Aluminio + Vidrio	IP66	Fácil Instalación
ARE-003	Reflector LED SMD Cuadrado Slim Blanco Frío	30W	90-277V~50/60Hz	3,300LM	120°	6500K	154x170x31mm	Aluminio + Vidrio	IP66	Fácil Instalación
ARE-004	Reflector LED SMD Cuadrado Slim Blanco Cálido	30W	90-277V~50/60Hz	3,150LM	120°	3000K	154x170x31mm	Aluminio + Vidrio	IP66	Fácil Instalación
ARE-005	Reflector LED SMD Cuadrado Slim Blanco Frío	50W	90-277V~50/60Hz	5,500LM	120°	6500K	183x205x32mm	Aluminio + Vidrio	IP66	Fácil Instalación
ARE-006	Reflector LED SMD Cuadrado Slim Blanco Cálido	50W	90-277V~50/60Hz	5,250LM	120°	3000K	183x205x32mm	Aluminio + Vidrio	IP66	Fácil Instalación
ARE-007	Reflector LED SMD Cuadrado Slim Blanco Frío	100W	90-277V~50/60Hz	11,000LM	120°	6500K	217x244x33mm	Aluminio + Vidrio	IP66	Fácil Instalación
ARE-011	Reflector LED SMD Cuadrado Slim Blanco Frío	150W	90-277V~50/60Hz	16,500LM	120°	6500K	249x277x33mm	Aluminio + Vidrio	IP66	Fácil Instalación
ARE-017	Reflector LED SMD Cuadrado Slim Blanco Frío	200W	90-277V~50/60Hz	22,000LM	120°	6500K	284x218x33mm	Aluminio + Vidrio	IP66	Fácil Instalación

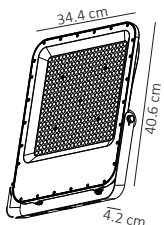
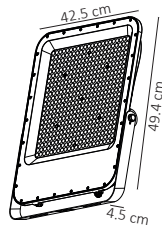
130
 LM/W
 EFICIENCIA

130
 LM/W
 EFICIENCIA

ARE-018

300W

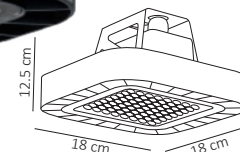
ARE-022

400W

ARE-015

50W

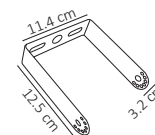
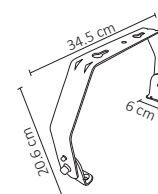
ACO-002

ACO-003

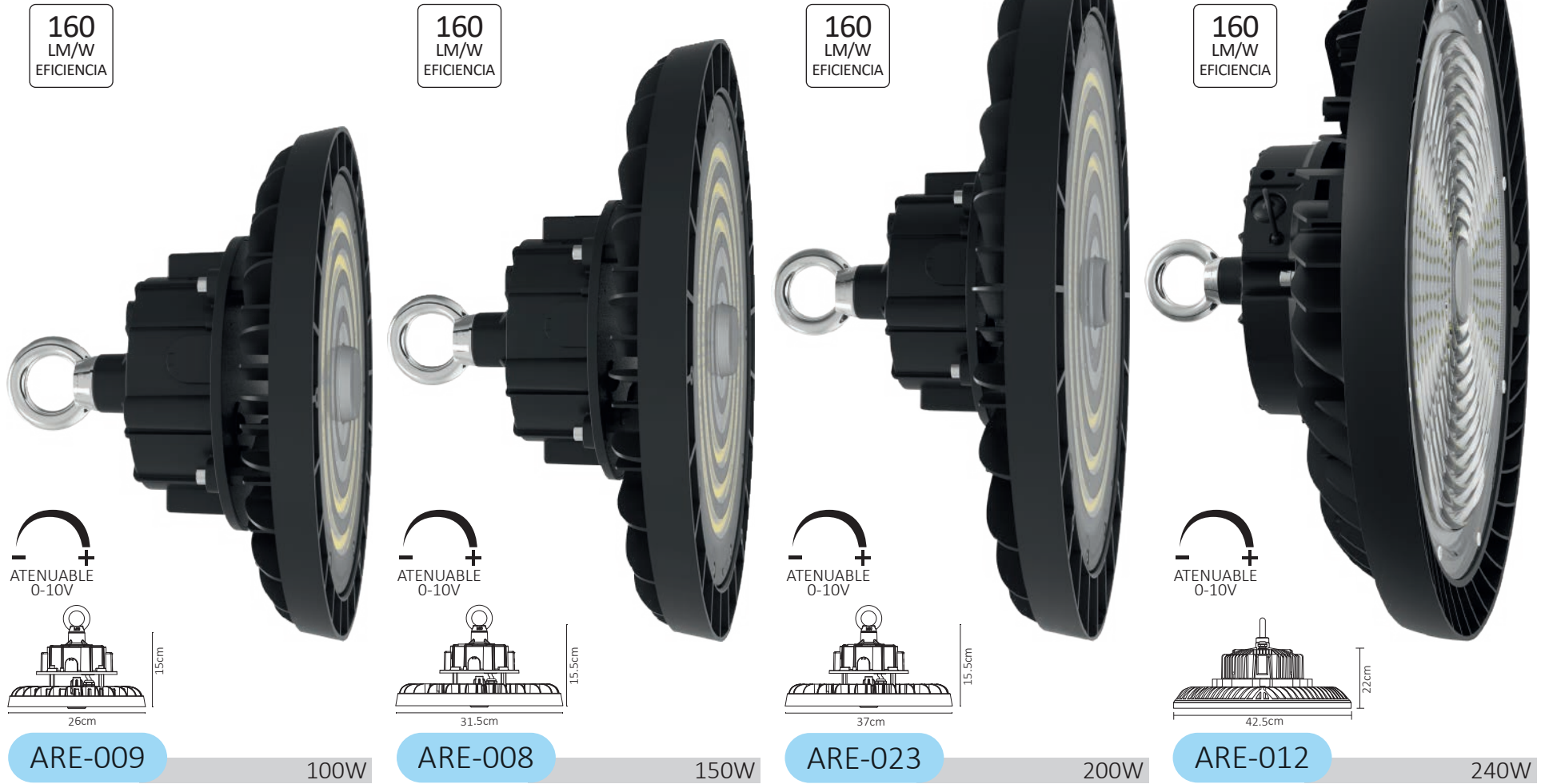
Código	Producto	Watts	Voltaje	Lúmenes	Apertura	Temp. Color	Dimensiones	Material	Protección	Observaciones
ARE-018	Reflector LED SMD Profesional Slim Blanco Frío	300W	90-277V~50/60Hz	39,000LM	90°	6500K	344x406x42mm	Aluminio + Vidrio	IP66	Fácil Instalación
ARE-022	Reflector LED SMD Profesional Slim Blanco Frío	400W	90-277V~50/60Hz	52,000LM	90°	6500K	425x494x45mm	Aluminio + Vidrio	IP66	Fácil Instalación
ARE-015	Campana Modular LED Exterior	50W	90-300V~50/60Hz	5,000LM	90°	6500K	180x180x125mm	Aluminio + PC	IP66	Se Puede Conectar en Grupo
ACO-002	Complemento para Fijar Campana Industrial 100W, 150W y 200W	-	-	-	-	-	114x125x32mm	Metal	-	Incluye 4 Tornillos Hexagonal 4mm de Punta Plana
ACO-003	Complemento para Fijar Campana Industrial 240W	-	-	-	-	-	206x345x60mm	Metal	-	Incluye 4 Tornillos Hexagonal 4mm de Punta Plana



ARE-009

100W

ARE-008

150W

ARE-023

200W

ARE-012

240W

#	💡	Ⓜ	⚡	☀️	360°	🌈	📏	💎	💧	🔍
Código	Producto	Watts	Voltaje	Lúmenes	Apertura	Temp. Color	Dimensiones	Material	Protección	Observaciones
ARE-009	Campana Industrial Slim LED Exterior Blanco Frío	100W	90-300V~50/60Hz	16,000LM	120°	5700K	D. 260x150mm	Aluminio + Policarbonato	IP66	No Incluye Complemento
ARE-008	Campana Industrial Slim LED Exterior Blanco Frío	150W	90-300V~50/60Hz	24,000LM	90°	5700K	D. 315x155mm	Aluminio + Policarbonato	IP66	No Incluye Complemento
ARE-023	Campana Industrial Slim LED Exterior Blanco Frío	200W	90-300V~50/60Hz	32,000LM	90°	5700K	D. 370x155mm	Aluminio + Policarbonato	IP66	No Incluye Complemento
ARE-012	Campana Industrial Slim LED Óptica Blanco Frío	240W	90-300V~50/60Hz	38,400LM	60°	5700K	D. 425x220mm	Aluminio + Policarbonato	IP66	No Incluye Complemento

Línea Solar

ASL-002

LUMINARIA LED SOLAR 2,300 LÚMENES
CON PANEL EXTERNO Y CONTROL REMOTO

PANEL: Monocristalino 5V 25Wp
MEDIDA PANEL: 530x350x17mm
TIEMPO DE CARGA: 5-6 Horas
DÍAS NUBLADOS: 3 Días
BATERÍA: 3.2V 20000mAh LiFePO4
WATTS *Equivalencia: 200W
TEMP. COLOR.: 6500K Blanco Frío
LED: SMD2835
ATENUABLE: SI
MEDIDA: 272x199x41mm
APERTURA: 90°
MATERIAL: Aluminio Gris
IP65 Exterior

2,300
LÚMENES



ASL-001

LUMINARIA LED SOLAR 1,000 LÚMENES
CON PANEL EXTERNO Y CONTROL REMOTO

PANEL: Monocristalino 5V 15Wp
MEDIDA PANEL: 350x350x17mm
TIEMPO DE CARGA: 5-6 Horas
DÍAS NUBLADOS: 3 Días
BATERÍA: 3.2V 10000mAh LiFePO4
WATTS *Equivalencia: 100W
TEMP. COLOR.: 6500K Blanco Frío
LED: SMD2835
ATENUABLE: SI
MEDIDA: 192x132x41mm
APERTURA: 90°
MATERIAL: Aluminio Gris
IP65 Exterior



EN CONDICIONES
NORMALES*

artlite
ILUMINACIÓN LED



*Potencia equivalente de una bombilla incandescente con un valor estimado de 10-12lm/W

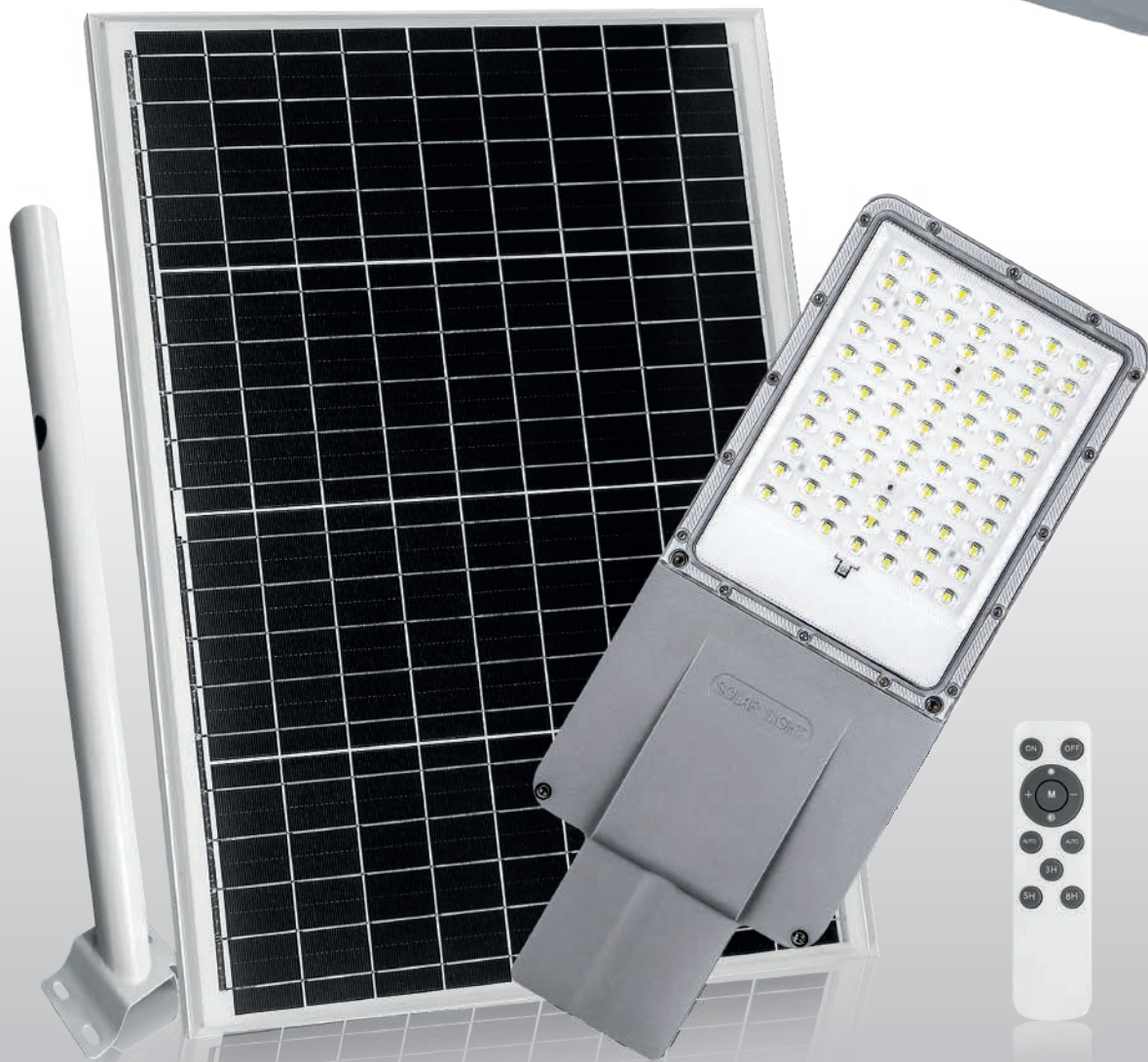
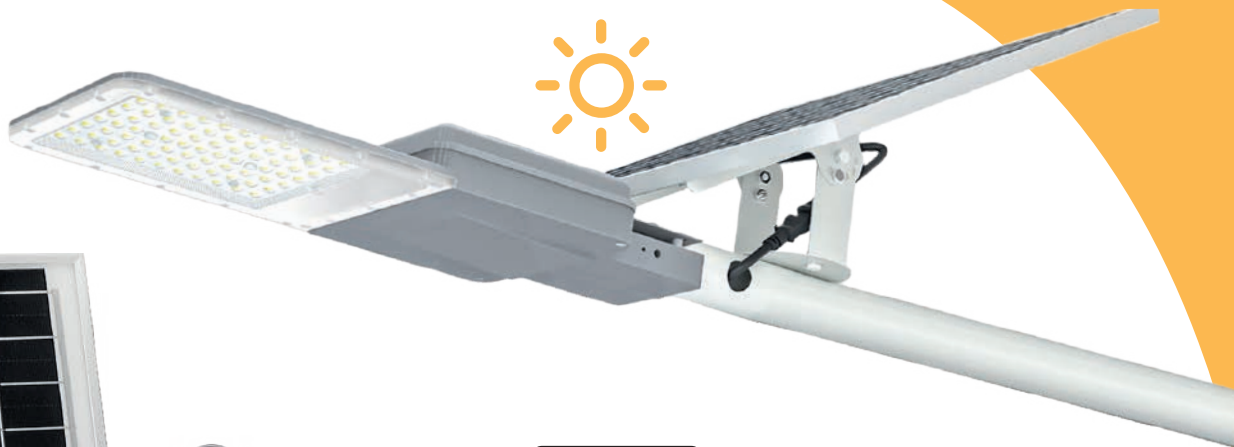

3,200
LÚMENES

ASL-003

*LUMINARIA LED SOLAR
3,200 LÚMENES
CON PANEL EXTERNO
Y CONTROL REMOTO*

PANEL: Monocristalino 5V 40Wp
MEDIDA PANEL: 670x350x17mm
TIEMPO DE CARGA: 5-6 Horas
DÍAS NUBLADOS: 3 Días
BATERÍA: 3.2V 40000mAh LiFePO4
WATTS *Equivalencia: 300W
TEMP. COLOR.: 6500K Blanco Frío
LED: SMD2835
ATENUABLE: SI
MEDIDA: 532x240x69mm
APERTURA: 120°x100°
MATERIAL: Aluminio Gris
IP65 Exterior



EN CONDICIONES
NORMALES*



*Potencia equivalente de una bombilla incandescente con un valor estimado de 10-12lm/W
*Altura máxima recomendada 6m.
*Incluye accesorio de instalación.

CABLE PARA CARGAR **ACO-008**
LUMINARIA SOLAR 50CM



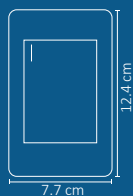
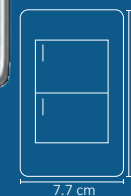

APL-101

APL-102

*Excepto 3 años de APL-107

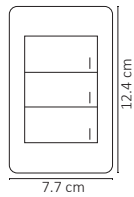

Código	Producto	Color	Voltaje	Corriente Eléctrica	Atenuador	Dimensiones	Material	Protección	Observaciones
APL-101	Placa Apagador 1 Interruptor y 3 Vías	Gris	90-277V~50/60Hz	15A	No	77x124mm	Acero Inox. + PC + Hierro Galvanizado	IP20	Interruptor 3 Vías
APL-102	Placa Apagador de 2 Interruptores y 3 Vías	Gris	90-277V~50/60Hz	15A	No	77x124mm	Acero Inox. + PC + Hierro Galvanizado	IP20	Interruptor 3 Vías



APL-103

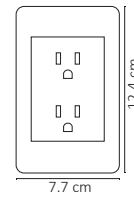

APL-104

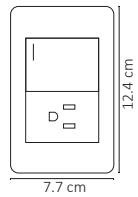

APL-105

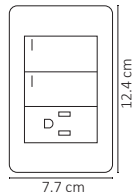

APL-106

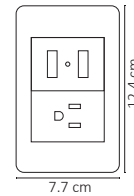

APL-107

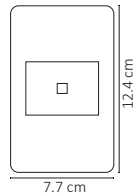

APL-108

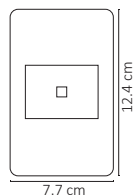
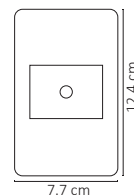
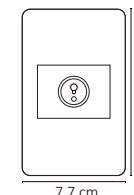
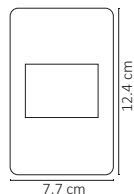
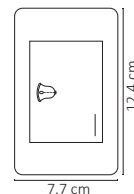
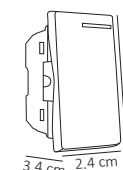

Código	Producto	Color	Voltaje	Corriente Eléctrica	Atenuador	Dimensiones	Material	Protección	Observaciones
APL-103	Placa Apagador de 3 Interruptores y 3 Vías	Gris	90-277V~50/60Hz	15A	No	77x124mm	Acero Inox. + PC + Hierro Galvanizado	IP20	Interruptor 3 Vías
APL-104	Placa de Contacto Doble	Gris	90-277V~50/60Hz	15A	No	77x124mm	Acero Inox. + PC + Hierro Galvanizado	IP20	2 Contactos
APL-105	Placa de Contacto y Apagador 1 Interruptor 3 Vías	Gris	90-277V~50/60Hz	15A	No	77x124mm	Acero Inox. + PC + Hierro Galvanizado	IP20	Interruptor 3 Vías
APL-106	Placa de Contacto y Apagador 2 Interruptores 3 Vías	Gris	90-277V~50/60Hz	15A	No	77x124mm	Acero Inox. + PC + Hierro Galvanizado	IP20	Interruptor 3 Vías
APL-107	Placa de Contacto y 2 Salidas Usb	Gris	90-277V~50/60Hz	15A	No	77x124mm	Acero Inox. + PC + Hierro Galvanizado	IP20	USB SALIDA 5V = Máx 2.1A
APL-108	Placa de Contacto Telefónico	Gris	N/A	N/A	No	77x124mm	Acero Inox. + PC + Hierro Galvanizado	IP20	Conector: RJ11

APL-109

APL-110

APL-111

APL-112

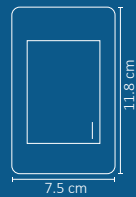
APL-113

APL-001

Código	Producto	Color	Voltaje	Corriente Eléctrica	Atenuador	Dimensiones	Material	Protección	Observaciones
APL-109	Placa de Contacto Red Lan Tipo RJ45 CAT5	Gris	N/A	N/A	No	77x124mm	Acero Inox. + PC + Hierro Galvanizado	IP20	RJ45 CAT5
APL-110	Placa de Contacto Coaxial para Televisión	Gris	N/A	N/A	No	77x124mm	Acero Inox. + PC + Hierro Galvanizado	IP20	Con Toma TV
APL-111	Placa de Contacto Atenuador Iluminación de 100W	Gris	100-127V~50/60Hz	0.78A	Sí	77x124mm	Acero Inox. + PC + Hierro Galvanizado	IP20	Atenuador
APL-112	Placa Tapa Ciega	Gris	N/A	N/A	No	77x124mm	Acero Inox. + PC + Hierro Galvanizado	IP20	Decorativo
APL-113	Placa de Contacto Timbre	Gris	90-127V~50/60Hz	15A	No	77x124mm	Acero Inox. + PC + Hierro Galvanizado	IP20	Timbre
APL-001	Módulo Apagador de 1 Interruptor y 4 Vías	Gris	90-277V~50/60Hz	15A	No	24x48x34mm	Acero Inox. + PC + Hierro Galvanizado	IP20	P/Circuito Escalera



APL-201



*Excepto 3 años de APL-207

#	💡	●	⚡	ⓐ	🕒	↔️	💎	💧	🔍
Código	Producto	Color	Voltaje	Corriente Eléctrica	Atenuador	Dimensiones	Material	Protección	Observaciones
APL-201	Placa Apagador 1 Interruptor y 3 Vías	Blanco	90-277V~50/60Hz	15A	No	75x118mm	Policarbonato + Hierro Galvanizado	IP20	Interruptor 3 Vías

Placas Premium Color Blanco

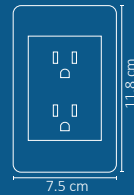
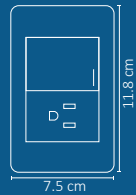
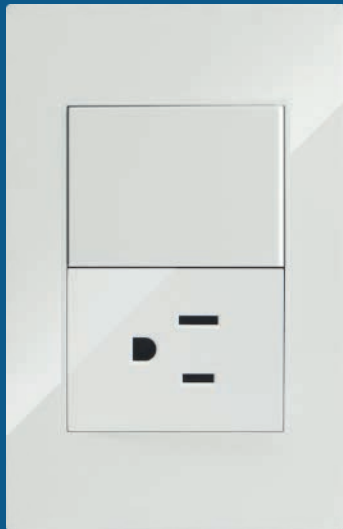
**APL-202****APL-203****APL-204****APL-205****APL-206****APL-207**

Código	Producto	Color	Voltaje	Corriente Eléctrica	Atenuador	Dimensiones	Material	Protección	Observaciones
APL-202	Placa Apagador de 2 Interruptores y 3 Vías	Blanco	90-277V~50/60Hz	15A	No	75x118mm	Policarbonato + Hierro Galvanizado	IP20	Interruptor 3 Vías
APL-203	Placa Apagador de 3 Interruptores y 3 Vías	Blanco	90-277V~50/60Hz	15A	No	75x118mm	Policarbonato + Hierro Galvanizado	IP20	Interruptor 3 Vías
APL-204	Placa de Contacto Doble	Blanco	90-277V~50/60Hz	15A	No	75x118mm	Policarbonato + Hierro Galvanizado	IP20	2 Contactos
APL-205	Placa de Contacto y Apagador 1 Interruptor 3 Vías	Blanco	90-277V~50/60Hz	15A	No	75x118mm	Policarbonato + Hierro Galvanizado	IP20	Interruptor 3 Vías
APL-206	Placa de Contacto y Apagador 2 Interruptores 3 Vías	Blanco	90-277V~50/60Hz	15A	No	75x118mm	Policarbonato + Hierro Galvanizado	IP20	Interruptor 3 Vías
APL-207	Placa de Contacto y 2 Salidas Usb	Blanco	90-277V~50/60Hz	15A	No	75x118mm	Policarbonato + Hierro Galvanizado	IP20	USB SALIDA 5V== Max 2.1A

Placas Premium Color Blanco



Código	Producto	Color	Voltaje	Corriente Eléctrica	Atenuador	Dimensiones	Material	Protección	Observaciones
APL-208	Placa de Contacto Telefónico	Blanco	N/A	N/A	No	75x118mm	Policarbonato + Hierro Galvanizado	IP20	Conector: RJ11
APL-209	Placa de Contacto Red Lan Tipo RJ45 CAT5	Blanco	N/A	N/A	No	75x118mm	Policarbonato + Hierro Galvanizado	IP20	RJ45 CAT5
APL-210	Placa de Contacto Coaxial para Televisión	Blanco	N/A	N/A	No	75x118mm	Policarbonato + Hierro Galvanizado	IP20	Con Toma TV
APL-211	Placa de Contacto Atenuador Iluminación de 100W	Blanco	100-127V~50/60Hz	0.78A	Si	75x118mm	Policarbonato + Hierro Galvanizado	IP20	Atenuador
APL-212	Placa Tapa Ciega	Blanco	N/A	N/A	No	75x118mm	Policarbonato + Hierro Galvanizado	IP20	Decorativo
APL-213	Placa de Contacto Timbre	Blanco	90-127V~50/60Hz	15A	No	75x118mm	Policarbonato + Hierro Galvanizado	IP20	Timbre

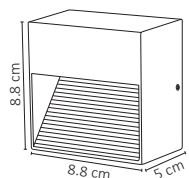

ADE-401

ADE-402



3W

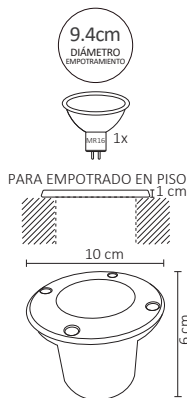

ADE-201

1xMR16



ADE-202

1xMR16

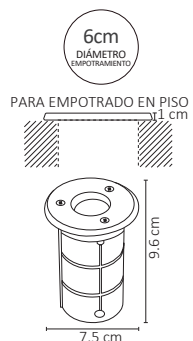

ADE-203

ADE-204



1W

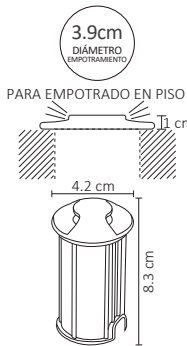

ADE-205

ADE-206



1W

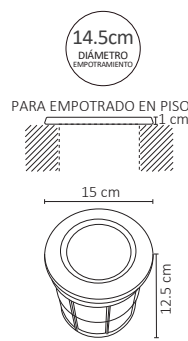

ADE-207

ADE-208



10W



Código	Producto	Watts	Voltaje	Lúmenes	Apertura	Temp. Color	Dimensiones	Material	Protección	Observaciones
ADE-401	Luminaria de Cortesía Blanco Frío	3W	90-260V~50/60Hz	80LM	90°	6500K	88x88x50mm	Aluminio + Plástico	IP54	Sobreponer/De Cortesía
ADE-402	Luminaria de Cortesía Blanco Cálido	3W	90-260V~50/60Hz	75LM	90°	3000K	88x88x50mm	Aluminio + Plástico	IP54	Sobreponer/De Cortesía
ADE-201	Luminaria de Piso Vidrio Templado	Máx. 50W	90-260V~50/60Hz	-	Máx. 90°	-	D. 100x60mm	Plástico + Vidrio Templ.	IP67	Emp./MR16/No Incluye Lámpara
ADE-202	Luminaria de Piso Satín y Vidrio Templado	Máx. 50W	90-260V~50/60Hz	-	Máx. 90°	-	D. 100x100mm	Plástico + Alum. + Vidrio	IP67	Emp./MR16/No Incluye Lámpara
ADE-203	Luminaria de Piso LED Mini Integrado Blanco Frío	1W	90-260V~50/60Hz	80LM	60°	6500K	D. 75x96mm	Plástico + Alum. + Vidrio	IP67	Empotrable/Diam. Emp. 60mm
ADE-204	Luminaria de Piso LED Mini Integrado Blanco Cálido	1W	90-260V~50/60Hz	75LM	60°	3000K	D. 75x96mm	Plástico + Alum. + Vidrio	IP67	Empotrable/Diam. Emp. 60mm
ADE-205	Luminaria de Piso Empotrable Blanco Frío	1W	90-260V~50/60Hz	80LM	60°/60°	6500K	D. 42x83mm	Aluminio + Plástico	IP67	Empotrable/Diam. Emp. 39mm
ADE-206	Luminaria de Piso Empotrable Blanco Cálido	1W	90-260V~50/60Hz	75LM	60°/60°	3000K	D. 42x83mm	Aluminio + Plástico	IP67	Empotrable/Diam. Emp. 39mm
ADE-207	Luminaria de Piso LED Óptica Exterior Blanco Frío	10W	90-260V~50/60Hz	800LM	40°	6500K	D. 150x125mm	Plástico + Acero + Vidrio	IP67	Empotrable/Diam. Emp. 145mm
ADE-208	Luminaria de Piso LED Óptica Exterior Blanco Cálido	10W	90-260V~50/60Hz	750LM	40°	3000K	D. 150x125mm	Plástico + Acero + Vidrio	IP67	Empotrable/Diam. Emp. 145mm



Código	Producto	Watts	Voltaje	Lúmenes	Apertura	Temp. Color	Dimensiones	Material	Protección	Observaciones
ADE-301	Luminaria para Jardín con Base Sobreponer	Max. 50W	90-260V~50/60Hz	-	90°	-	121x111x92mm	Plástico + Vidrio + Alum.	IP65	Sob./MR16/No Incluye Lámpara
ADE-302	Luminaria para Jardín Estaca	Máx. 50W	90-260V~50/60Hz	-	90°	-	365x75mm	Aluminio + Vidrio	IP54	MR16/No Incluye Lámpara
ADE-305	Luminaria LED Jardín Estaca Negra Blanco Frío	10W	90-260V~50/60Hz	850LM	40°	6500K	110x390x150mm	Aluminio + Vidrio	IP65	Estaca para Jardín
ADE-306	Luminaria LED Jardín Estaca Negra Blanco Cálido	10W	90-260V~50/60Hz	800LM	40°	3000K	110x390x150mm	Aluminio + Vidrio	IP65	Estaca para Jardín
ACO-004	Complemento ADE-305 y ADE-306 para Sobreponer en Piso	-	-	-	-	-	140x50mm	Aluminio	IP65	Base Complemento



#	💡	Ⓜ	⚡	☀️	360°	🌈	↔️	💎	💧	🔍
Código	Producto	Watts	Voltaje	Lúmenes	Apertura	Temp. Color	Dimensiones	Material	Protección	Observaciones
ADE-303	Luminaria Tipo Mini Poste Exterior Blanco Frío	10W	90-260V~50/60Hz	900LM	90°	6500K	120x800x160mm	Aluminio + PC	IP54	Sobreponer en Piso
ADE-304	Luminaria Tipo Mini Poste Exterior Blanco Cálido	10W	90-260V~50/60Hz	850LM	90°	3000K	120x800x160mm	Aluminio + PC	IP54	Sobreponer en Piso
ADE-307	Luminaria LED Tubular Rectangular Blanco Frío	10W	90-260V~50/60Hz	900LM	120°/120°	6500K	160x600x55mm	Aluminio + Plástico	IP54	Sobreponer en Piso
ADE-308	Luminaria LED Tubular Rectangular Blanco Cálido	10W	90-260V~50/60Hz	850LM	120°/120°	3000K	160x600x55mm	Aluminio + Plástico	IP54	Sobreponer en Piso
ADE-309	Luminaria Mini Poste Cilindro Sob. Aluminio Gris	Máx. 50W	90-260V~50/60Hz	-	Máx. 300°	-	90x500mm	Aluminio + PC	IP54	Sob./E26/No incluye Lámpara
ADE-010	Luminaria de Pared Exterior Blanco Frío	10W	90-260V~50/60Hz	850LM	90°	6500K	80x240x160mm	Aluminio + Plástico	IP54	Sobreponer en Pared
ADE-011	Luminaria de Pared Exterior Blanco Cálido	10W	90-260V~50/60Hz	800LM	90°	3000K	80x240x160mm	Aluminio + Plástico	IP54	Sobreponer en Pared
ADE-016	Luminaria Pared Cilíndrica Más PC Aluminio Gris	Máx. 50W	90-260V~50/60Hz	-	Máx. 300°	-	90x270x130mm	Aluminio + PC	IP54	Sob./E26/No incluye Lámpara



ADE-014

ADE-015

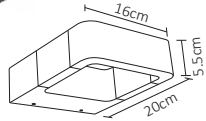

10W

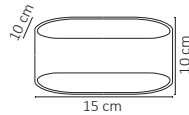

ADE-001

ADE-002



6W



ADE-007

ADE-008

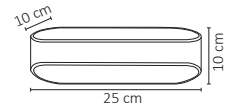

12W

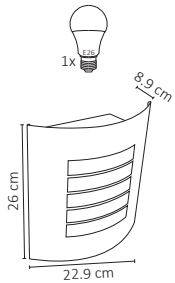

ADE-005

1xE26

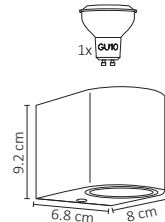

ADE-003

1xGU10

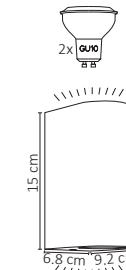
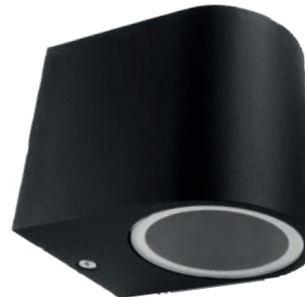

ADE-004

2xGU10



Código	Producto	Watts	Voltaje	Lúmenes	Apertura	Temp. Color	Dimensiones	Material	Protección	Observaciones
ADE-014	Luminaria LED de Pared Tubular Aluminio Negro Exterior Blanco Frío	10W	90-260V~50/60Hz	850LM	120°/120°	6500K	200x160x55mm	Aluminio + Plástico	IP54	Sobreponer
ADE-015	Luminaria LED de Pared Tubular Aluminio Negro Exterior Blanco Cálido	10W	90-260V~50/60Hz	800LM	120°/120°	3000K	200x160x55mm	Aluminio + Plástico	IP54	Sobreponer
ADE-001	Luminaria de Pared LED Exterior Blanco Frío	6W	90-260V~50/60Hz	450LM	45°/45°	6500K	150x100x100mm	Aluminio + Plástico	IP54	Sobreponer
ADE-002	Luminaria de Pared LED Exterior Blanco Cálido	6W	90-260V~50/60Hz	600LM	45°/45°	3000K	150x100x100mm	Aluminio + Plástico	IP54	Sobreponer
ADE-007	Luminaria de Pared LED Exterior Blanco Frío	12W	90-260V~50/60Hz	550LM	45°/45°	6500K	250x100x100mm	Aluminio + Plástico	IP54	Sobreponer
ADE-008	Luminaria de Pared LED Exterior Blanco Cálido	12W	90-260V~50/60Hz	450LM	45°/45°	3000K	250x100x100mm	Aluminio + Plástico	IP54	Sobreponer
ADE-005	Luminaria de Pared Pantalla con Rejilla	Máx. 50W	90-260V~50/60Hz	-	Máx. 120°	-	229x260x89mm	Acero Inox. + Plástico	IP54	Sob./E26/No incluye lámpara
ADE-003	Luminaria de Pared Cilindro	Máx. 50W	90-260V~50/60Hz	-	Máx. 90°	-	68x80x92mm	Alum. + Vidrio + Plástico	IP54	Sob./GU10/No incluye Lámpara
ADE-004	Luminaria de Pared Cilindro Doble	Máx. 50W	90-260V~50/60Hz	-	Máx. 90°	-	60x150x92mm	Alum. + Vidrio + Plástico	IP54	Sob./GU10/No incluye Lámpara

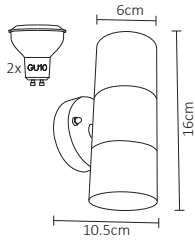

ADE-013

2xGU10

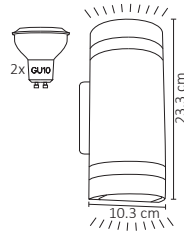

ADE-006

2xGU10

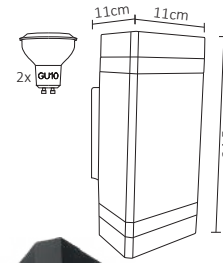

ADE-012

2xGU10

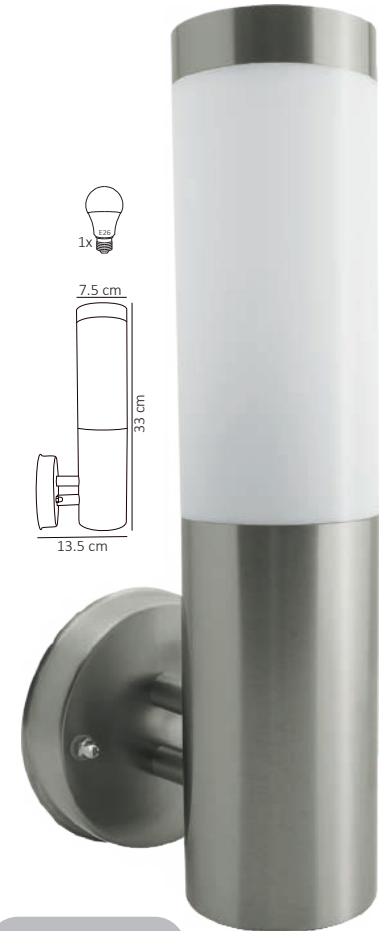
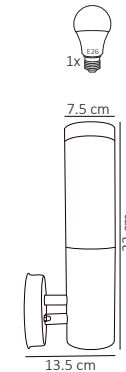

ADE-017

1xE26



Código	Producto	Watts	Voltaje	Lúmenes	Apertura	Temp. Color	Dimensiones	Material	Protección	Observaciones
ADE-013	Luminaria de Pared Cilindro Doble Satín Exterior Base GU10	Máx. 50W	90-260V~50/60Hz	-	-	-	60x160x105mm	Aluminio + Vidrio	IP54	Sob./2xGU10/No incluyen lámp.
ADE-006	Luminaria Cilindro Doble Aro	Máx. 50W	90-260V~50/60Hz	-	Máx. 90°/90°	-	103x233x108mm	Alum. + Plástico + PC	IP54	Sob./2xGU10/No incluyen lámp.
ADE-012	Luminaria de Pared Rectangular Doble Aluminio Negro Exterior Base GU10	Máx. 50W	90-260V~50/60Hz	-	Máx. 80°/80°	-	110x250x110mm	Alum. + Plástico + PC	IP54	Sob./2xGU10/No incluyen lámp.
ADE-017	Luminaria Pared Cilindro Vertical Cubierta Opalino	Máx. 50W	90-260V~50/60Hz	-	-	-	75x330x135mm	PC + Acero Inoxidable	IP54	Sob./1xE26/No incluyen lámp.

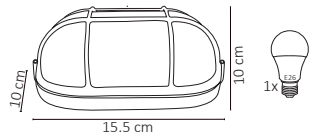

ADE-018

1xE26

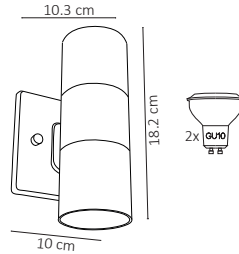

ADE-019

2xGU10

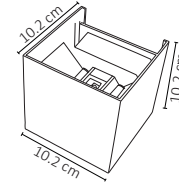

ADE-020

ADE-021

6W

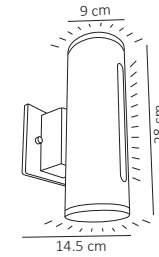

ADE-022

ADE-023

11W

#	💡	Ⓜ	⚡	☀️	360°	🌈	↔️	💎	💧	🔍
Código	Producto	Watts	Voltaje	Lúmenes	Apertura	Temp. Color	Dimensiones	Material	Protección	Observaciones
ADE-018	Luminaria Pared Nautica Rejilla Negra Cub. Opalina	Máx. 50W	90-260V~50/60Hz	-	-	-	145x100x100mm	Aluminio + Vidrio	IP54	Sob./1xE26/No incluye lámpara
ADE-019	Luminaria Pared Cilindro Doble Negro Mate	Máx. 50W	90-260V~50/60Hz	-	-	-	103x182x100mm	Aluminio + Vidrio Temp.	IP54	Sob./2xGU10/No incluye lámpara
ADE-020	Luminaria Led Pared Cubo Doble Disparo y Angulo Ajustable Blanco Frío Negro Mate	6W	90-260V~50/60Hz	360LM	2x45°	6500K	102x102mm	Aluminio	IP54	Fácil Instalación Angulo Ajustable
ADE-021	Luminaria Led Pared Cubo Doble Disparo y Angulo Ajustable Blanco Cálido Negro Mate	6W	90-260V~50/60Hz	350LM	2x45°	3000K	102x102mm	Aluminio	IP54	Fácil Instalación Angulo Ajustable
ADE-022	Luminaria Pared Cilindro Doble con Lineal Frontal Blanco Frío	11W	90-260V~50/60Hz	700LM	2x150°	6500K	114x280x145mm	Aluminio + PC	IP54	Sobreponer en Pared
ADE-023	Luminaria Pared Cilindro Doble con Lineal Frontal Blanco Cálido	11W	90-260V~50/60Hz	650LM	2x150°	3000K	114x280x145mm	Aluminio + PC	IP54	Sobreponer en Pared

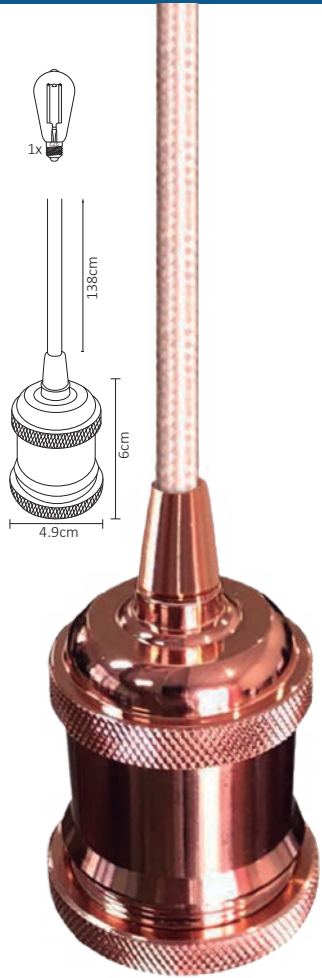

ADE-601

1xE26



ADE-602

1xE26

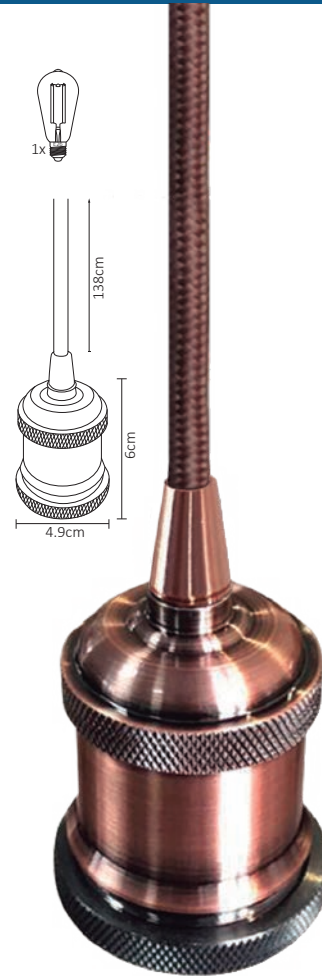

ADE-603

1xE26

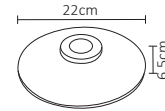

ACO-005

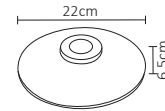
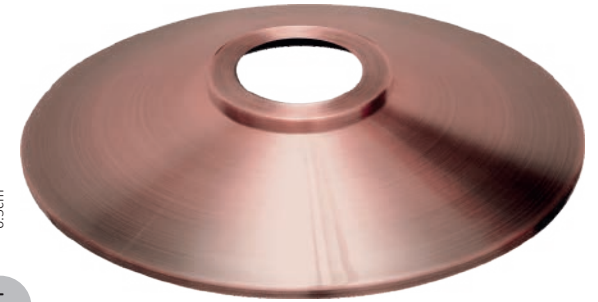

ACO-006

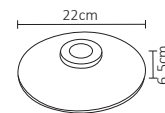

ACO-007



Código	Producto	Watts	Voltaje	Lúmenes	Apertura	Temp. Color	Dimensiones	Material	Protección	Observaciones
ADE-601	Colgante Vintage Bulbo E26 Oro Rosado	Máx. 50W	90-260V~50/60Hz	-	Máx. 320°	-	D. 49x60mm	Aluminio + Nailon	IP20	No incluye lámpara E26 Medida del cable: 138cm
ADE-602	Colgante Vintage Bulbo E26 Negro Pulido	Máx. 50W	90-260V~50/60Hz	-	Máx. 320°	-	D. 49x60mm	Aluminio + Nailon	IP20	No incluye lámpara E26 Medida del cable: 138cm
ADE-603	Colgante Vintage Bulbo E26 Cobre Antiguo	Máx. 50W	90-260V~50/60Hz	-	Máx. 320°	-	D. 49x60mm	Aluminio + Nailon	IP20	No incluye lámpara E26 Medida del cable: 138cm
ACO-005	Complemento Redondo para ADE-601 Oro Rosado	-	-	-	-	-	D. 220x65mm	Aluminio	IP20	No incluye colgante
ACO-006	Complemento Redondo para ADE-602 Negro Pulido	-	-	-	-	-	D. 220x65mm	Aluminio	IP20	No incluye colgante
ACO-007	Complemento Redondo para ADE-603 Cobre Antiguo	-	-	-	-	-	D. 220x65mm	Aluminio	IP20	No incluye colgante

Decorativos Colgantes



ADE-604

1xE26

ADE-605

1xE26

ADE-606

1xE26

ADE-607

1xGU10

ADE-608

1xGU10

Código	Producto	Watts	Voltaje	Lúmenes	Apertura	Temp. Color	Dimensiones	Material	Protección	Observaciones
ADE-604	Colgante Cilíndrico Bulbo E26 Oro Rosado	Max. 50W	90-260V~50/60Hz	-	Máx. 320°	-	D. 45x64mm	Aluminio + Nailon	IP20	No incluye lámpara E26 Medida del cable: 138cm
ADE-605	Colgante Cilíndrico Bulbo E26 Negro Pulido	Máx. 50W	90-260V~50/60Hz	-	Máx. 320°	-	D. 45x64mm	Aluminio + Nailon	IP20	No incluye lámpara E26 Medida del cable: 138cm
ADE-606	Colgante Cilíndrico Bulbo E26 Cobre Antiguo	Máx. 50W	90-260V~50/60Hz	-	Máx. 320°	-	D. 45x64mm	Aluminio + Nailon	IP20	No incluye lámpara E26 Medida del cable: 138cm
ADE-607	Colgante Cubierta Cilíndrica Aluminio Blanco	Máx. 50W	90-260V~50/60Hz	-	Máx. 120°	-	D. 170x55mm	Aluminio	IP20	Base GU10/Med. Cable: 80 cm
ADE-608	Colgante Cubierta Cilíndrica Aluminio Negro	Máx. 50W	90-260V~50/60Hz	-	Máx. 120°	-	D. 170x55mm	Aluminio	IP20	Base GU10/Med. Cable: 80 cm



ADE-501

12 x E26



ADE-609

ADE-610

40W

Código	Producto	Watts	Voltaje	Lúmenes	Apertura	Temp. Color	Dimensiones	Material	Protección	Observaciones
ADE-501	Extensión de Sockets para 12 Bulbos	Máx. 50W	90-260V~50/60Hz	-	Máx. 320°	-	Extensión 7.5m	Plástico	IP65	12 Bases E26/No incluye focos
ADE-609	Luminaria LED Colgante Negro Blanco Frío	40W	90-260V~50/60Hz	3,100LM	120°	6500K	1200x35x70mm	Aluminio + PC	IP20	Med. Cable: 148 cm
ADE-610	Luminaria LED Colgante Negro Blanco Cálido	40W	90-260V~50/60Hz	3,400LM	120°	3000K	1200x35x70mm	Aluminio + PC	IP20	Med. Cable: 148 cm

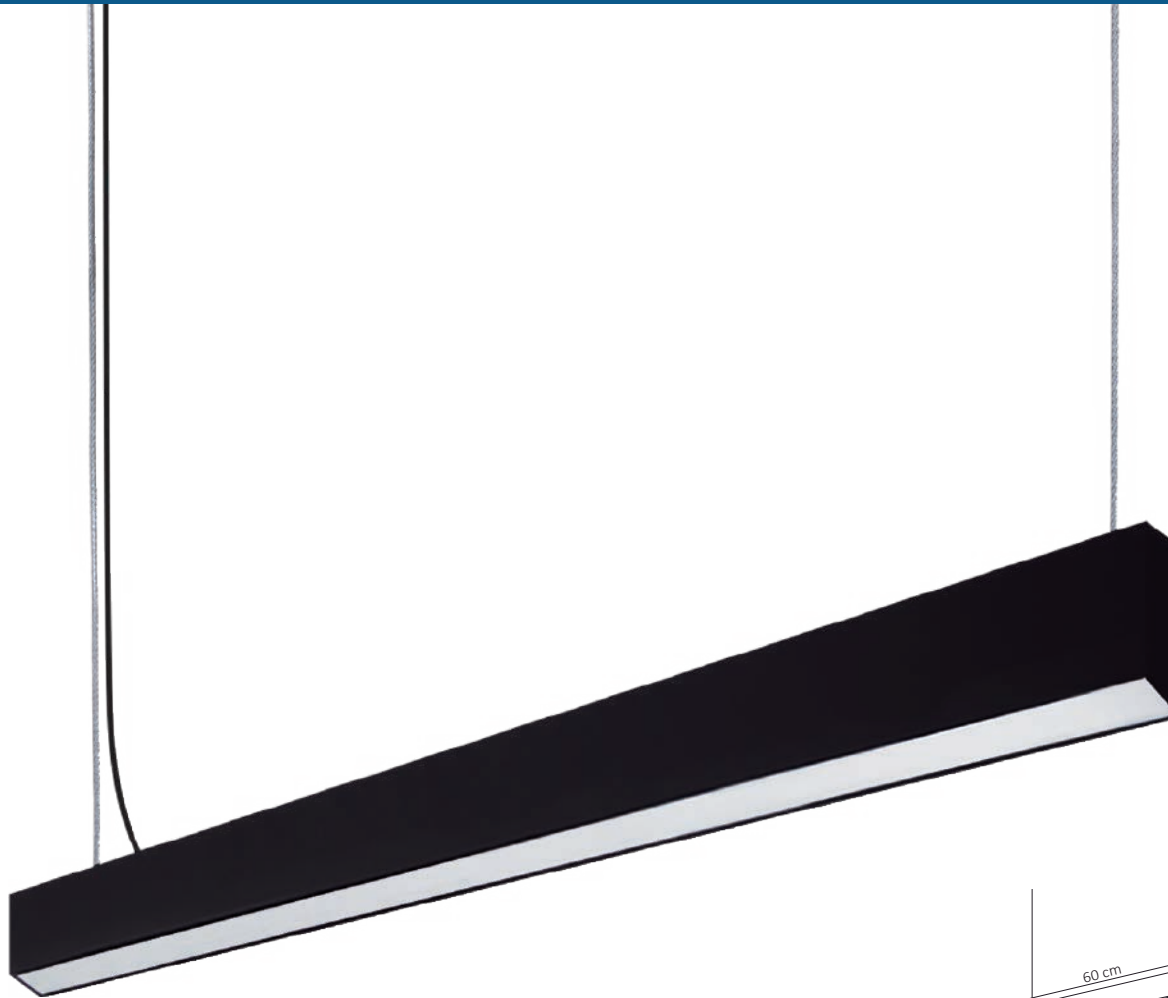

ADE-611

ADE-612

20W

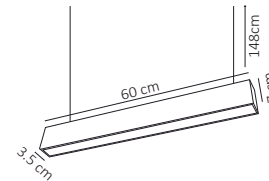

ADE-701

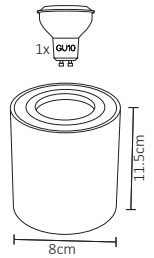

1xGU10



ADE-702

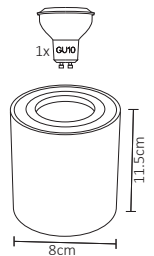

1xGu10

#	💡	Ⓜ	⚡	☀️	360°	🌈	↔️	💎	💧	🔍
Código	Producto	Watts	Voltaje	Lúmenes	Apertura	Temp. Color	Dimensiones	Material	Protección	Observaciones
ADE-611	Luminaria LED Colgante Negro Blanco Frío	20W	90-260V~50/60Hz	1,550LM	120°	6500K	600x35x70mm	Aluminio + Policarbonato	IP20	Med. Cable: 100 cm
ADE-612	Luminaria LED Colgante Negro Blanco Cálido	20W	90-260V~50/60Hz	1,500LM	120°	3000K	600x35x70mm	Aluminio + Policarbonato	IP20	Med. Cable: 100 cm
ADE-701	Luminaria Sobreponer Techo Cilíndrico Dirigible Aluminio Blanco para GU10	Máx. 50W	90-260V~50/60Hz	-	Máx. 120°	-	D. 80x115mm	Aluminio	IP20	Sob./1xGU10/No incluye lámpara
ADE-702	Luminaria Sobreponer Techo Cilíndrico Dirigible Aluminio Negro para GU10	Máx. 50W	90-260V~50/60Hz	-	Máx. 120°	-	D. 80x115mm	Aluminio	IP20	Sob./1xGU10/No incluye lámpara



ADE-101

1xMR16

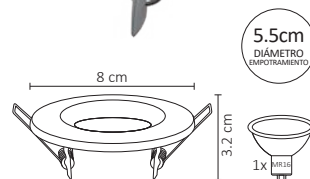

ADE-102

1xMR16

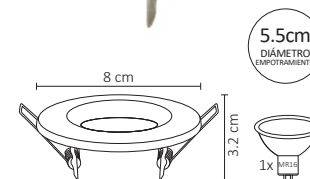

ADE-103

1xMR16

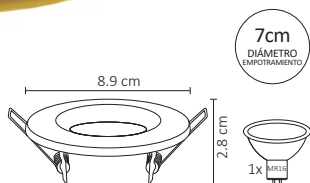

ADE-104

1xMR16

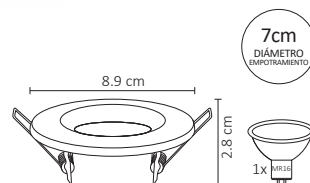

ADE-105

1xMR16

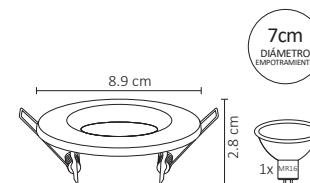

ADE-106

1xMR16

#	💡	W	⚡	360°	↔	💎	💧	🔍
Código	Producto	Watts	Voltaje	Apertura	Dimensiones	Material	Protección	Observaciones
ADE-101	Empotrable Fijo Aro Metálico Negro	Máx. 50W	90-260V~50/60Hz	Máx. 120°	D. 80x32mm	Metal	IP20	Base MR16 / No Incluye Lámpara / Emp. 55mm
ADE-102	Empotrable Fijo Aro Metálico Blanco	Máx. 50W	90-260V~50/60Hz	Máx. 120°	D. 80x32mm	Metal	IP20	Base MR16 / No Incluye Lámpara / Emp. 55mm
ADE-103	Empotrable Fijo Aro Metálico Satín	Máx. 50W	90-260V~50/60Hz	Máx. 120°	D. 80x32mm	Metal	IP20	Base MR16 / No Incluye Lámpara / Emp. 55mm
ADE-104	Empotrable Dirigible Aro Metálico Negro	Máx. 50W	90-260V~50/60Hz	Máx. 120°	D. 89x28mm	Metal	IP20	Base MR16 / No Incluye Lámpara / Emp. 70mm
ADE-105	Empotrable Dirigible Aro Metálico Blanco	Máx. 50W	90-260V~50/60Hz	Máx. 120°	D. 89x28mm	Metal	IP20	Base MR16 / No Incluye Lámpara / Emp. 70mm
ADE-106	Empotrable Dirigible Aro Metálico Satín	Máx. 50W	90-260V~50/60Hz	Máx. 120°	D. 89x28mm	Metal	IP20	Base MR16 / No Incluye Lámpara / Emp. 70mm



9x9cm
MEDIDA
EMPOTRAMIENTO

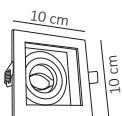

17.5x9cm
MEDIDA
EMPOTRAMIENTO



26x9cm
MEDIDA
EMPOTRAMIENTO

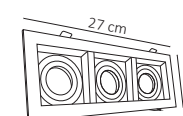

ADE-107

1xMR16

ADE-109

2xMR16

ADE-111

3xMR16



9x9cm
MEDIDA
EMPOTRAMIENTO

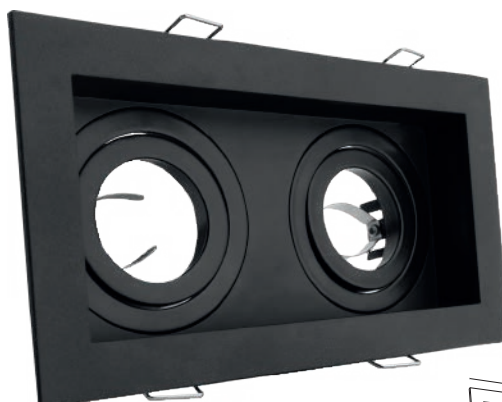
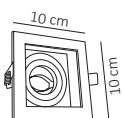

17.5x9cm
MEDIDA
EMPOTRAMIENTO



26x9cm
MEDIDA
EMPOTRAMIENTO

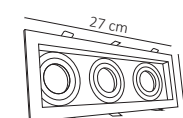

ADE-108

1xMR16

ADE-110

2xMR16

ADE-112

3xMR16



Código	Producto	Watts	Voltaje	Apertura	Dimensiones	Material	Protección	Observaciones
ADE-107	Empotrable Dirigible para Spot Sencillo Blanco 1xGU10	Máx. 50W	90-260V~50/60Hz	Máx. 120°	100x100x40mm	Metal	IP20	1xMR16/No Incluye Lámpara/Emp. 90x90mm
ADE-108	Empotrable Dirigible para Spot Sencillo Negro 1xGU10	Máx. 50W	90-260V~50/60Hz	Máx. 120°	100x100x40mm	Metal	IP20	1xMR16/No Incluye Lámpara/Emp. 90x90mm
ADE-109	Empotrable Dirigible para Spot Doble Blanco 2xGU10	Máx. 50W	90-260V~50/60Hz	Máx. 120°	185x100x40mm	Metal	IP20	2xMR16/No Incluye Lámpara/Emp. 175x90mm
ADE-110	Empotrable Dirigible para Spot Doble Negro 2xGU10	Máx. 50W	90-260V~50/60Hz	Máx. 120°	185x100x40mm	Metal	IP20	2xMR16/No Incluye Lámpara/Emp. 175x90mm
ADE-111	Empotrable Dirigible para Spot Triple Blanco 3xGU10	Máx. 50W	90-260V~50/60Hz	Máx. 120°	270x100x40mm	Metal	IP20	3xMR16/No Incluye Lámpara/Emp. 260x90mm
ADE-112	Empotrable Dirigible para Spot Triple Negro 3xGU10	Máx. 50W	90-260V~50/60Hz	Máx. 120°	270x100x40mm	Metal	IP20	3xMR16/No Incluye Lámpara/Emp. 260x90mm

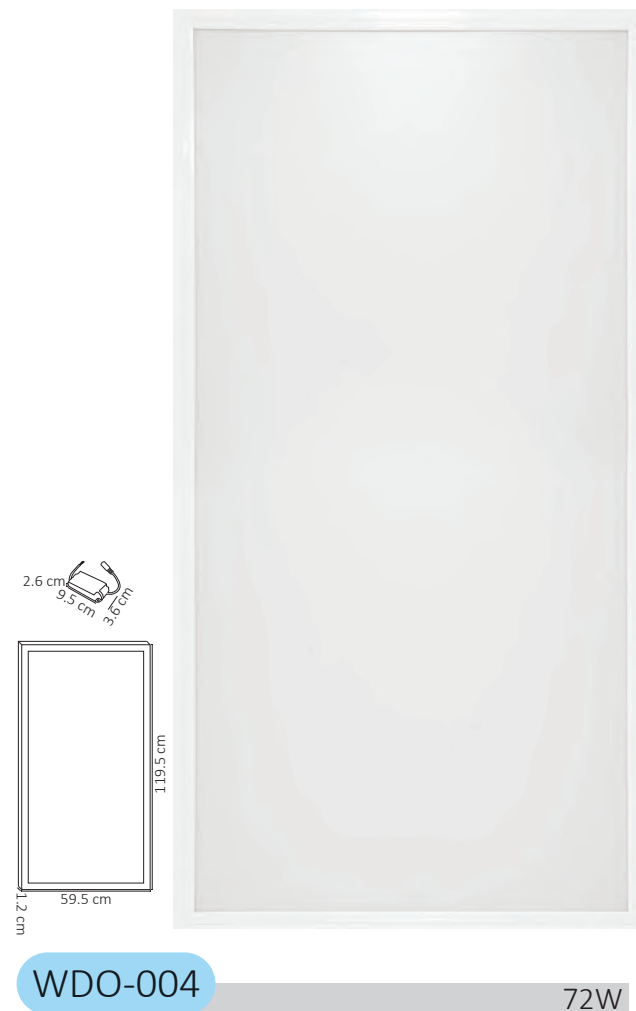
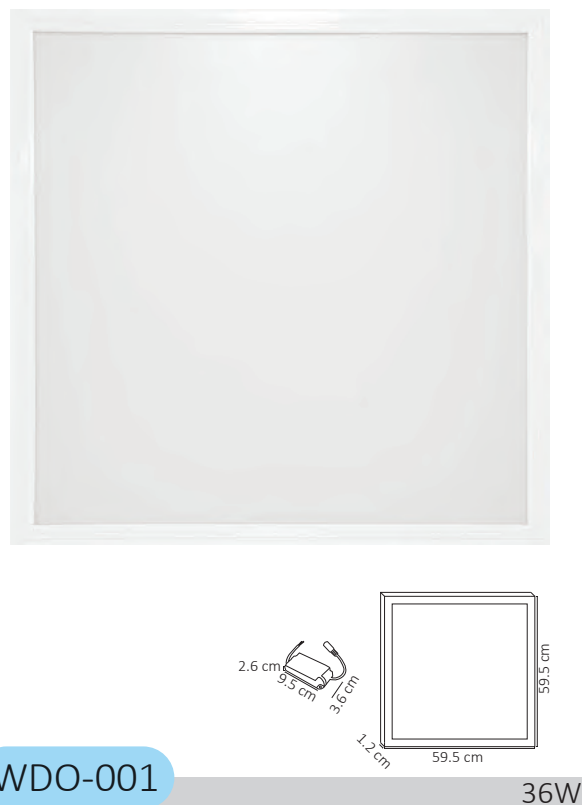

Código	Producto	Watts	Voltaje	Lúmenes	Apertura	Temp. Color	Dimensiones	Material	Protección	Observaciones
WDO-002	Pánel LED Redondo 5W Blanco Frío	5W	90-260V~50/60Hz	380LM	120°	6500K	D. 95x38mm	Plástico + Policarbonato	IP20	Diam. Emp. 8.5cm/Incluye driver
WDO-005	Pánel LED Redondo 5W Blanco Cálido	5W	90-260V~50/60Hz	330LM	120°	3000K	D. 95x38mm	Plástico + Policarbonato	IP20	Diam. Emp. 8.5cm/Incluye driver
WDO-003	Pánel LED Redondo 12W Blanco Frío	12W	90-260V~50/60Hz	900LM	120°	6500K	D. 140x48mm	Plástico + Policarbonato	IP20	Diam. Emp. 12cm/Incluye driver
WDO-006	Pánel LED Redondo 12W Blanco Cálido	12W	90-260V~50/60Hz	850LM	120°	3000K	D. 140x48mm	Plástico + Policarbonato	IP20	Diam. Emp. 12cm/Incluye driver
WDO-001	Pánel LED Cuadrado Empotrable Blanco Frío	36W	90-260V~50/60Hz	3,000LM	120°	6500K	595x595x12mm	Aluminio + Policarbonato	IP20	Incluye driver y sujetadores
WDO-004	Pánel LED Rectangular Empotrable Blanco Frío	72W	90-260V~50/60Hz	6,000LM	120°	6500K	1195x595x12mm	Aluminio + Policarbonato	IP20	Incluye driver y sujetadores

Páneles LED Ajustables



DIÁMETRO
D
AJUSTABLE

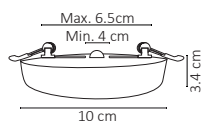

WDO-008

WDO-009

10W

DIÁMETRO
D
AJUSTABLE

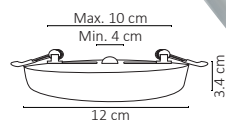

WDO-010

WDO-011

18W

DIÁMETRO
D
AJUSTABLE

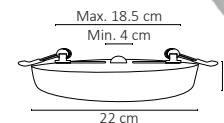

WDO-012

WDO-013

36W

Código	Producto	Watts	Voltaje	Lúmenes	Apertura	Temp. Color	Dimensiones	Material	Protección	Observaciones
WDO-008	Pánel LED Emp. Ajustable 10W Blanco Frío	10W	90-260V~50/60Hz	1,100LM	240°	6500K	D. 100x34mm	Policarbonato	IP20	Diámetro Empotramiento Ajustable Máx.:6.5cm Min.:4cm / Incluye driver
WDO-009	Pánel LED Emp. Ajustable 10W Blanco Cálido	10W	90-260V~50/60Hz	1,000LM	240°	3000K	D. 100x34mm	Policarbonato	IP20	Diámetro Empotramiento Ajustable Máx.:6.5cm Min.:4cm / Incluye driver
WDO-010	Pánel LED Emp. Ajustable 18W Blanco Frío	18W	90-260V~50/60Hz	1,950LM	240°	6500K	D. 120x34mm	Policarbonato	IP20	Diámetro Empotramiento Ajustable Máx.:10cm Min.:4cm / Incluye driver
WDO-011	Pánel LED Emp. Ajustable 18W Blanco Cálido	18W	90-260V~50/60Hz	1,800LM	240°	3000K	D. 120x34mm	Policarbonato	IP20	Diámetro Empotramiento Ajustable Máx.:10cm Min.:4cm / Incluye driver
WDO-012	Pánel LED Emp. Ajustable 36W Blanco Frío	36W	90-260V~50/60Hz	3,950LM	240°	6500K	D. 220x34mm	Policarbonato	IP20	Diámetro Empotramiento Ajustable Máx.:18.5cm Min.:4cm / Incluye driver
WDO-013	Pánel LED Emp. Ajustable 36W Blanco Cálido	36W	90-260V~50/60Hz	3,600LM	240°	3000K	D. 220x34mm	Policarbonato	IP20	Diámetro Empotramiento Ajustable Máx.:18.5cm Min.:4cm / Incluye driver



WGA-001

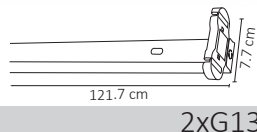

2xG13



WGA-002



1xG13

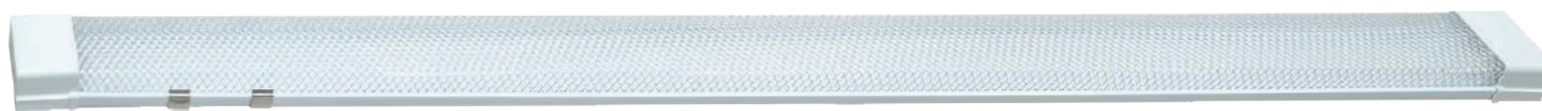

WGA-003

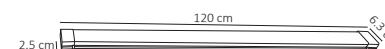

36W



WTU-006



9W



WTU-003

WTU-004

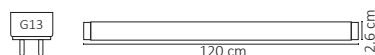

18W



WTU-005

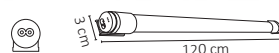

18W



WTU-007

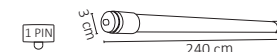

36W



Código	Producto	Watts	Voltaje	Lúmenes	Apertura	Temp. Color	Dimensiones	Material	Protección	Observaciones
WGA-001	Gabinete Canaleta Doble T8 120cm	Máx. 50W	90-260V~50/60Hz	-	-	-	1217x77x40mm	Metal	IP20	P/2 Tubos T8 G13/No Incluye Tubos
WGA-002	Gabinete Canaleta 1xT8 120cm	Máx. 50W	90-260V~50/60Hz	-	-	-	1217x57x40mm	Metal	IP20	P/1 Tubo T8 G13/No Incluye Tubo
WGA-003	Gabinete Slim LED Integrado Tipo Regleta Escolar	36W	90-260V~50/60Hz	3,600LM	120°	6500K	1200x63x25mm	Polycarbonato	IP20	Sobreponer/LED Integrado
WTU-006	Tubo LED Base de Plástico Transparente Blanco Frío	9W	90-260V~50/60Hz	800LM	120°	6500K	600x30mm	Vidrio + Plástico	IP20	Con Base
WTU-005	Tubo LED Base de Plástico Transparente Blanco Frío	18W	90-260V~50/60Hz	1,600LM	120°	6500K	1200x30mm	Vidrio + Plástico	IP20	Con Base
WTU-003	Tubo LED Vidrio Transparente Blanco Frío	18W	90-260V~50/60Hz	1,750LM	120°	6500K	1200x26mm	Vidrio + Plástico	IP20	Conexión 2 Polos
WTU-004	Tubo LED Vidrio Opalino Blanco Frío	18W	90-260V~50/60Hz	1,700LM	150°	6500K	1200x26mm	Vidrio Opalino + Plástico	IP20	Conexión 2 Polos
WTU-007	Tubo LED -1 PIN- Transparente T8 Blanco Frío	36W	90-260V~50/60Hz	3,000LM	120°	6500K	2400x30mm	Vidrio + Plástico	IP20	Incluye Aro Sujetador

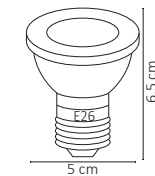
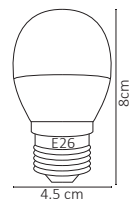
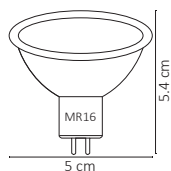

WLA-012
WLA-013

3W

WLA-006
WLA-007

3W

WLA-005

3W

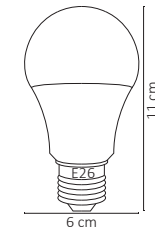
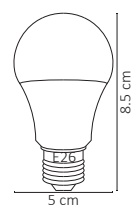

WLA-001
WLA-008

5W

WLA-002
WLA-009

10W

Código	Producto	Watts	Voltaje	Lúmenes	Apertura	Temp. Color	Dimensiones	Material	Protección	Observaciones
WLA-012	Lámpara LED Spot MR16 Blanco Frío	3W	100-140V~50/60Hz	270LM	120°	6500K	50x55mm	Plástico	IP20	MR16
WLA-013	Lámpara LED Spot MR16 Blanco Cálido	3W	100-140V~50/60Hz	250LM	120°	3000K	50x55mm	Plástico	IP20	MR16
WLA-006	Lámpara LED Bulbo E26 Blanco Frío	3W	100-140V~50/60Hz	250LM	220°	6500K	45x80mm	Aluminio + Plástico + PC	IP20	E26
WLA-007	Lámpara LED Bulbo E26 Blanco Cálido	3W	100-140V~50/60Hz	230LM	220°	3000K	45x80mm	Aluminio + Plástico + PC	IP20	E26
WLA-005	Lámpara LED Spot E26 RGB	3W	90-260V~50/60Hz	200LM	30°	Multicolor	50x65mm	Aluminio + Plástico	IP20	E26 / Incluye Control
WLA-001	Lámpara LED Bulbo E26 Blanco Frío	5W	100-140V~50/60Hz	430LM	220°	6500K	50x85mm	Aluminio + Plástico + PC	IP20	E26
WLA-008	Lámpara LED Bulbo E26 Blanco Cálido	5W	100-140V~50/60Hz	400LM	220°	3000K	50x85mm	Aluminio + Plástico + PC	IP20	E26
WLA-002	Lámpara LED Bulbo E26 Blanco Frío	10W	100-140V~50/60Hz	850LM	220°	6500K	60x110mm	Aluminio + Plástico + PC	IP20	E26
WLA-009	Lámpara LED Bulbo E26 Blanco Cálido	10W	100-140V~50/60Hz	800LM	220°	3000K	60x110mm	Aluminio + Plástico + PC	IP20	E26

3 PACK

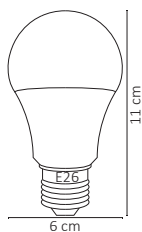
WLA-014
WLA-015

3 de 10W

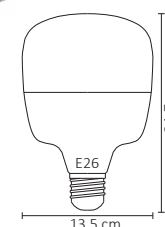

WLA-010

20W

WLA-011

50W

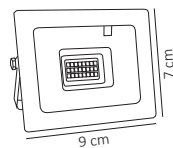
#	💡	Ⓜ	⚡	☀️	360°	🌈	↔️	💎	💧	🔍
Código	Producto	Watts	Voltaje	Lúmenes	Apertura	Temp. Color	Dimensiones	Material	Protección	Observaciones
WLA-014	Foco Lámpara 3 Pack LED Bulbo E26 10W Blanco Frío	3 x 10W	100-140V~50/60Hz	850LM	220°	6500K	60x110mm	Aluminio + Plástico + PC	IP20	Incluye 3 Lámparas
WLA-015	Foco Lámpara 3 Pack LED Bulbo E26 10W Blanco Cálido	3 x 10W	100-140V~50/60Hz	800LM	220°	3000K	60x110mm	Aluminio + Plástico + PC	IP20	Incluye 3 Lámparas
WLA-010	Lámpara Industrial LED E26 Blanco Frío	20W	90-260V~50/60Hz	1,700LM	150°	6500K	80x152mm	Aluminio + Policarbonato	IP20	Base E26
WLA-011	Lámpara Industrial LED E26 Blanco Frío	50W	90-260V~50/60Hz	4,500LM	150°	6500K	135x247mm	Aluminio + Policarbonato	IP20	Base E26



WRE-004

10W

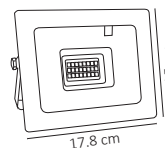

WRE-006

50W

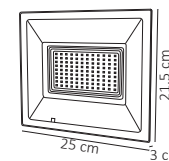

WRE-015

100W

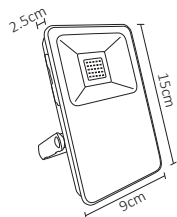

WRE-011

10W

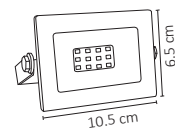
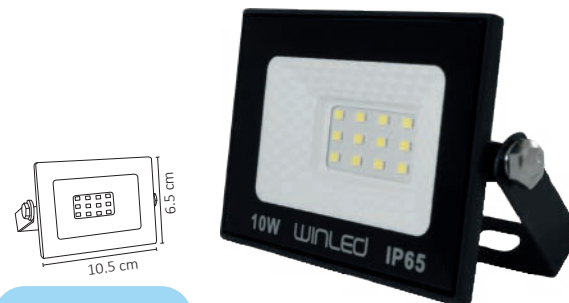

WRE-008

10W

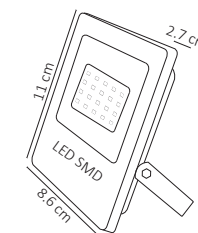

WRE-009

20W

#	💡	W	⚡	☀️	360°	🌈	📏	💎	💧	🔍
Código	Producto	Watts	Voltaje	Lúmenes	Apertura	Temp. Color	Dimensiones	Material	Protección	Observaciones
WRE-004	Reflector LED 10W SMD RGB con Control Remoto	10W	90-260V~50/60Hz	Máx. 700LM	220°	Multicolor	90x70x28mm	Aluminio + Vidrio	IP65	Incluye Control
WRE-006	Reflector LED 50W SMD RGB con Control Remoto	50W	90-260V~50/60Hz	Máx 3,000LM	220°	Multicolor	178x150x28mm	Aluminio + Vidrio	IP65	Incluye Control
WRE-015	Reflector LED 100W SMD RGB con Control Remoto	100W	90-260V~50/60Hz	Máx 6,000LM	220°	Multicolor	250x215x30mm	Aluminio + Vidrio	IP65	Incluye Control
WRE-011	Reflector SMD Portatil Recargable USB	10W	90-260V~50/60Hz	Máx. 800LM	120°	6500K	150x90x25mm	Plástico + Vidrio	IP54	Batería Portatil y USB. Cambio de Intensidad y Colores (Azul y Rojo)
WRE-008	Reflector LED SMD Cuadrado Blanco Frío Exterior	10W	90-260V~50/60Hz	850LM	120°	6500K	105x65x25mm	Aluminio + Vidrio	IP65	Fácil Instalación
WRE-009	Reflector LED SMD Cuadrado Blanco Frío Exterior	20W	90-260V~50/60Hz	1700LM	120°	6500K	86x110x27mm	Aluminio + Vidrio	IP65	Fácil Instalación

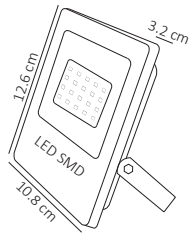

WRE-012

30W

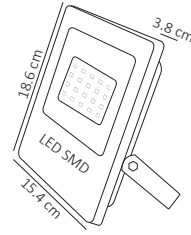

WRE-013

50W

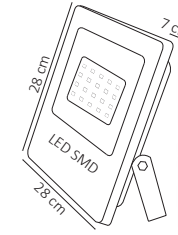

WRE-014

100W

120
LM/W
EFICIENCIA



WRE-007

100W

120
LM/W
EFICIENCIA



WRE-010

200W

DISPONIBLES
JUNIO
2022

#	💡	Ⓜ	⚡	☀️	360°	🌈	↔️	💎	💧	🔍
Código	Producto	Watts	Voltaje	Lúmenes	Apertura	Temp. Color	Dimensiones	Material	Protección	Observaciones
WRE-012	Reflector LED SMD Cuadrado Blanco Frío Exterior	30W	90-260V~50/60Hz	2,550LM	120°	6500K	108x126x32mm	Aluminio + Vidrio	IP65	Fácil Instalación
WRE-013	Reflector LED SMD Cuadrado Blanco Frío Exterior	50W	90-260V~50/60Hz	4,250LM	120°	6500K	154x186x38mm	Aluminio + Vidrio	IP65	Fácil Instalación
WRE-014	Reflector LED SMD Cuadrado Blanco Frío Exterior	100W	90-260V~50/60Hz	9,000LM	120°	6500K	280x280x70mm	Aluminio + Vidrio	IP65	Fácil Instalación
WRE-007	Campana LED Slim Grafeno Multivoltaje Exterior	100W	90-277V~50/60Hz	12,000LM	90°	6500K	D. 270x40mm	Aluminio + PC	IP66	Fácil Instalación
WRE-010	Campana LED Slim Grafeno Multivoltaje Exterior	180W	90-277V~50/60Hz	24,000LM	90°	6500K	D. 380x40mm	Aluminio + PC	IP66	Fácil Instalación

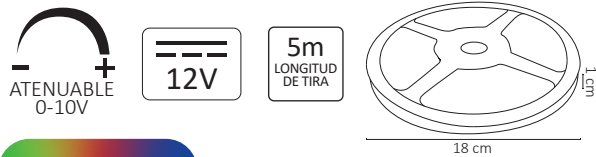

WTI-001

36W

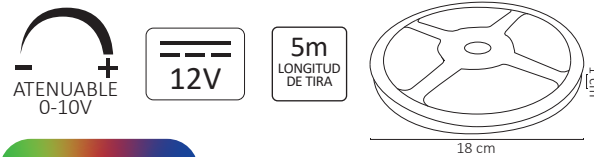

WTI-002

72W



WTI-012

72W

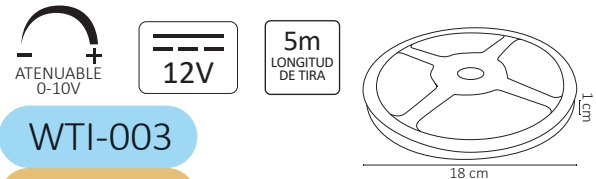

WTI-003

72W



WTI-005

24W

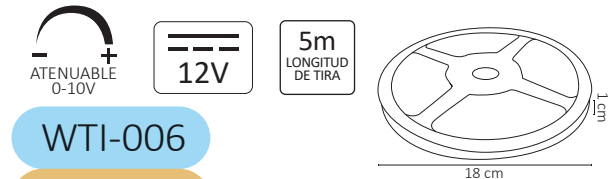

WTI-006

24W

WTI-004

WTI-007

#	💡	Ⓜ	⚡	☀️	360°	🌈	↔️	💎	💧	🔍
Código	Producto	Watts	Voltaje	Lúmenes	Apertura	Temp. Color	Dimensiones	Material	Protección	Observaciones
WTI-001	Tira 150 LEDs 5050 Exterior RGB	36W	12V===	900-1,800LM	120°	Multicolor	5000x10x2mm	Cubierta de Silicón	IP65	*Atenuable / Corte cada 3 leds
WTI-002	Tira 300 LEDs 5050 Exterior RGB	72W	12V===	700-3,500LM	120°	Multicolor	5000x10x2mm	Cubierta de Silicón	IP65	*Atenuable / Corte cada 3 leds
WTI-012	Tira 300 LEDs 5050 Interior Blanco Frío	72W	12V===	3,600LM	120°	6500K	5000x10x2mm	Tira Flexible Adhesiva	IP20	*Atenuable / Sin Recubrimiento
WTI-003	Tira 300 LEDs 5050 Exterior Blanco Frío	72W	12V===	3,600LM	120°	6500K	5000x10x2mm	Cubierta de Silicón	IP65	*Atenuable / Corte cada 3 leds
WTI-004	Tira 300 LEDs 5050 Exterior Blanco Cálido	72W	12V===	3,400LM	120°	3000K	5000x10x2mm	Cubierta de Silicón	IP65	*Atenuable / Corte cada 3 leds
WTI-005	Tira 300 LEDs 2835 Interior Blanco Frío	24W	12V===	1,300LM	120°	6500K	5000x10x2mm	Tira Flexible Adhesiva	IP20	*Atenuable / Sin Recubrimiento
WTI-006	Tira 300 LEDs 2835 Exterior Blanco Frío	24W	12V===	1,300LM	120°	6500K	5000x10x2mm	Cubierta de Silicón	IP65	*Atenuable / Corte cada 3 leds
WTI-007	Tira 300 LEDs 2835 Exterior Blanco Cálido	24W	12V===	1,250LM	120°	3000K	5000x10x2mm	Cubierta de Silicón	IP65	*Atenuable / Corte cada 3 leds

*Requiere un dimmer compatible de corriente directa para atenuar las tiras.

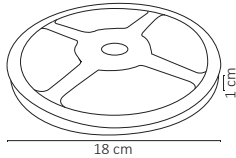

WTI-008

24W

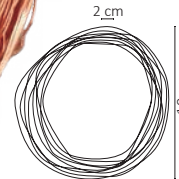
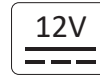

WTI-016

2W

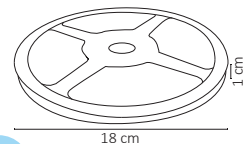

WTI-013

WTI-014

WTI-015

50W



#	💡	Ⓜ	⚡	☀️	360°	🌈	↔️	💎	💧	🔍
Código	Producto	Watts	Voltaje	Lúmenes	Apertura	Temp. Color	Dimensiones	Material	Protección	Observaciones
WTI-008	Tira 300 LEDs 2835 5M 24W Exterior Azul	24W	12V===	280LM	120°	Azul	5000x8x2mm	Cubierta de Silicón	IP65	*Atenuable / Corte cada 3 leds
WTI-016	Tira LED Arroz 10M 2W Exterior Blanco Cálido	2W	12V===	130LM	120°	3000K	10000x3mm	Cable de Cobre + Silicón	IP65	12 Volts CD / *Atenuable
WTI-013	Tira LED COB Continuo 5M 50W Blanco Cálido	50W	24V===	4,000LM	120°	3000K	5000x10mm	Tira Flexible Adhesiva	IP20	24 Volts CD / *Atenuable
WTI-014	Tira LED COB Continuo 5M 50W Blanco Neutro	50W	24V===	4,150LM	120°	4000K	5000x10mm	Tira Flexible Adhesiva	IP20	24 Volts CD / *Atenuable
WTI-015	Tira LED COB Continuo 5M 50W Blanco Frío	50W	24V===	4,250LM	120°	6500K	5000x10mm	Tira Flexible Adhesiva	IP20	24 Volts CD / *Atenuable

*Requiere un dimmer compatible de corriente directa para atenuar las tiras.

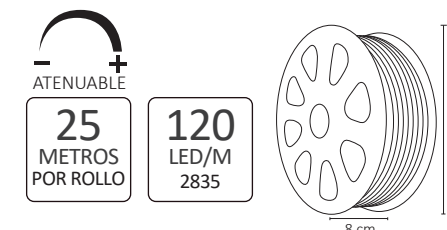
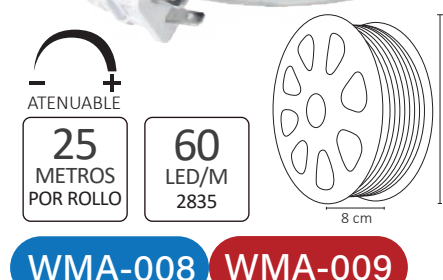
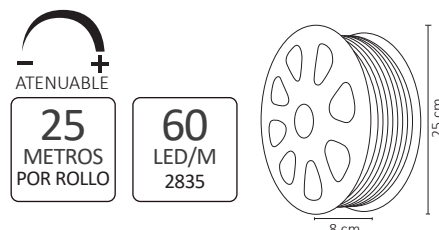
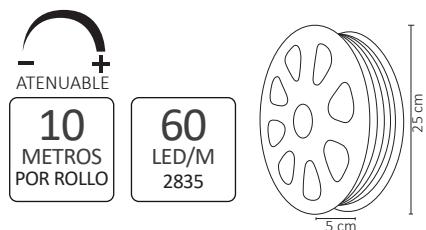

WMA-012 WMA-013

40W

WMA-006 WMA-007

100W

WMA-008 WMA-009
WMA-010 WMA-011

100W

WMA-014 WMA-015

150W

#	💡	W	⚡	☀️	360°	🌈	↔️	💎	💧	🔍
Código	Producto	Watts	Voltaje	Lúmenes	Apertura	Temp. Color	Dimensiones	Material	Protección	Observaciones
WMA-012	Manguera LED 2835 10m Exterior Blanco Frío	40W	127V~50/60Hz	2,800LM	120°	6500K	10000x11x6.5mm	Silicón	IP65	Se Puede Cortar Cada 1 Metro
WMA-013	Manguera LED 2835 10m Exterior Blanco Cálido	40W	127V~50/60Hz	2,720LM	120°	3000K	10000x11x6.5mm	Silicón	IP65	Se Puede Cortar Cada 1 Metro
WMA-006	Manguera LED 2835 25m Exterior Blanco Frío	100W	127V~50/60Hz	7,000LM	120°	6500K	25000x11x6.5mm	Silicón	IP65	Se Puede Cortar Cada 1 Metro
WMA-007	Manguera LED 2835 25m Exterior Blanco Cálido	100W	127V~50/60Hz	6,800LM	120°	3000K	25000x11x6.5mm	Silicón	IP65	Se Puede Cortar Cada 1 Metro
WMA-008	Manguera LED 2835 25m Exterior Azul	100W	127V~50/60Hz	1,750LM	120°	Azul	25000x11x6.5mm	Silicón	IP65	Se Puede Cortar Cada 1 Metro
WMA-009	Manguera LED 2835 25m Exterior Rojo	100W	127V~50/60Hz	2,300LM	120°	Rojo	25000x11x6.5mm	Silicón	IP65	Se Puede Cortar Cada 1 Metro
WMA-010	Manguera LED 2835 25m Exterior Verde	100W	127V~50/60Hz	3,500LM	120°	Verde	25000x11x6.5mm	Silicón	IP65	Se Puede Cortar Cada 1 Metro
WMA-011	Manguera LED 2835 25m Exterior Amarillo	100W	127V~50/60Hz	3,500LM	120°	Amarillo	25000x11x6.5mm	Silicón	IP65	Se Puede Cortar Cada 1 Metro
WMA-014	Manguera Doble LED 2835 25m Blanco Frío	150W	127V~50/60Hz	10,500LM	120°	6500K	25000x11x6.5mm	Silicón	IP65	Se Puede Cortar Cada 1 Metro
WMA-015	Manguera Doble LED 2835 25m Blanco Cálido	150W	127V~50/60Hz	10,500LM	120°	3000K	25000x11x6.5mm	Silicón	IP65	Se Puede Cortar Cada 1 Metro

*Para atenuar las mangueras LED se requiere el accesorio WAC-016 (se vende por separado).



*Colores de mangueras simulando el color de luz.

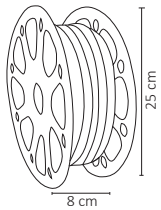

WMA-016

WMA-017

WMA-018

WMA-019

WMA-020

150W

#	💡	Ⓜ	⚡	☀️	360°	🌈	📏	💎	💧	🔍
Código	Producto	Watts	Voltaje	Lúmenes	Apertura	Temp. Color	Dimensiones	Material	Protección	Observaciones
WMA-016	Manguera Neón Doble LED 2835 25m Blanco Frío	150W	127V~50/60Hz	7,200LM	150°	6500K	25000x9x14mm	Silicón	IP65	Neón / Corte Cada 50cm.
WMA-017	Manguera Neón Doble LED 2835 25m Blanco Cálido	150W	127V~50/60Hz	7,000LM	150°	3000K	25000x9x14mm	Silicón	IP65	Neón / Corte Cada 50cm.
WMA-018	Manguera Neón Doble LED 2835 25m Verde	150W	127V~50/60Hz	2,250LM	150°	Verde	25000x9x14mm	Silicón	IP65	Neón / Corte Cada 50cm.
WMA-019	Manguera Neón Doble LED 2835 25m Azul	150W	127V~50/60Hz	1,000LM	150°	Azul	25000x9x14mm	Silicón	IP65	Neón / Corte Cada 50cm.
WMA-020	Manguera Neón Doble LED 2835 25m Rojo	150W	127V~50/60Hz	1,000LM	150°	Rojo	25000x9x14mm	Silicón	IP65	Neón / Corte Cada 50cm.

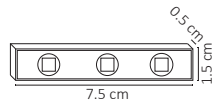

WMO-001

0.72W

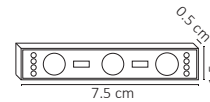

WMO-008

WMO-009

0.72W

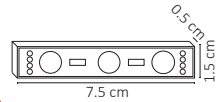

WMO-010

WMO-011

WMO-012

WMO-013

0.72W



WMO-014

WMO-015

WMO-016

1.4W

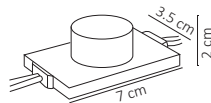

WMO-017

WMO-018

WMO-019

1W

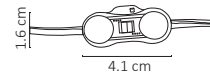

WMO-020

WMO-021

1.6W

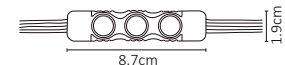

#	💡	Ⓜ	⚡	☀️	360°	🌈	↔️	💎	💧	🔍
Código	Producto	Watts	Voltaje	Lúmenes	Apertura	Temp. Color	Dimensiones	Material	Protección	Observaciones
WMO-001	Módulo 3 LEDs SMD 5050 Exterior RGB	0.72W	12V==	15-40LM	120°	Multicolor	75x15x5mm	Plástico + Policarbonato	IP65	RGB
WMO-008	Módulo 3 LEDs SMD 2835 Exterior Blanco Frío	0.72W	12V==	60LM	120°	6500K	75x15x5mm	Plástico + Policarbonato	IP65	Blanco Frío
WMO-009	Módulo 3 LEDs SMD 2835 Exterior Blanco Cálido	0.72W	12V==	55LM	120°	3000K	75x15x5mm	Plástico + Policarbonato	IP65	Blanco Cálido
WMO-010	Módulo 3 LEDs SMD 2835 Exterior Azul	0.72W	12V==	15LM	120°	Azul	75x15x5mm	Plástico + Policarbonato	IP65	Azul
WMO-011	Módulo 3 LEDs SMD 2835 Exterior Rojo	0.72W	12V==	20LM	120°	Rojo	75x15x5mm	Plástico + Policarbonato	IP65	Rojo
WMO-012	Módulo 3 LEDs SMD 2835 Exterior Verde	0.72W	12V==	30LM	120°	Verde	75x15x5mm	Plástico + Policarbonato	IP65	Verde
WMO-013	Módulo 3 LEDs SMD 2835 Exterior Amarillo	0.72W	12V==	30LM	120°	Amarillo	75x15x5mm	Plástico + Policarbonato	IP65	Amarillo
WMO-014	Módulo Super LED con Óptica Exterior Blanco Frío	1.4W	12V==	130LM	120°	6500K	70x35x20mm	Plástico + Policarbonato	IP65	Blnaco Frío
WMO-015	Módulo Super LED con Óptica Exterior Azul	1.4W	12V==	25LM	120°	Azul	70x35x20mm	Plástico + Policarbonato	IP65	Azul
WMO-016	Módulo Super LED con Óptica Exterior Rojo	1.4W	12V==	30LM	120°	Rojo	70x35x20mm	Plástico + Policarbonato	IP65	Rojo
WMO-017	Módulo LED x2 Samsung SMD 2835 Blanco Cálido	1W	12V==	100LM	120°	3000K	16x41mm	Plástico + Policarbonato	IP67	Blanco Cálido
WMO-018	Módulo LED x2 Samsung SMD2 835 Blanco Neutro	1W	12V==	100LM	150°	4000K	16x41mm	Plástico + Policarbonato	IP67	Blanco Neutro
WMO-019	Módulo LED x2 Samsung SMD 2835 Blanco Frío	1W	12V==	100LM	150°	6500K	16x41mm	Plástico + Policarbonato	IP67	Blanco Frío
WMO-020	Módulo LED 3xSMD 2835 Blanco Frío	1.6W	100-135V~50/60Hz	115LM	150°	6500K	87x19x9mm	Plástico + Policarbonato	IP67	Trabajan de 2 en 2
WMO-021	Módulo LED 3xSMD 2835 Blanco Cálido	1.6W	100-135V~50/60Hz	115LM	120°	3000K	87x19x9mm	Plástico + Policarbonato	IP67	Trabajan de 2 en 2

80%
Eficiencia

12V

WEL-001



24W

80%
Eficiencia

12V

WEL-002



60W

90%
Eficiencia

12V

WEL-005



60W

90%
Eficiencia

12V

WEL-006



100W

90%
Eficiencia

IP63
A Prueba de Lluvias

12V

WEL-007



200W

90%
Eficiencia

IP63
A Prueba de Lluvias

12V

WEL-008



350W

24V

90%
Eficiencia

WEL-011



100W

#	💡	W	⚡	🔋	⚙️	📏	💎	💧	🔍
Código	Producto	Watts	Voltaje	Voltaje de Salida	Eficiencia	Dimensiones	Material	Protección	Observaciones
WEL-001	Eliminador de Voltaje CD 12V a 2A Interior	24W	90-260V~50/60Hz	12V==	80%	82x45x30mm	Plástico	IP20	Medida del Cable: 150cm
WEL-002	Eliminador de Voltaje CD 12V a 5A Interior	60W	90-260V~50/60Hz	12V==	80%	120x60x40mm	Plástico	IP20	Medida de los Cables: 121cm c/u
WEL-005	Fuente de Poder CD 12V a 8.3A Aluminio Interior	60W	90-260V~50/60Hz	12V==	90%	170x34x23mm	Aluminio	IP20	Compatible con Tiras 12V CD
WEL-006	Fuente de Poder CD 12V a 8.3A Aluminio Resistente	100W	90-260V~50/60Hz	12V==	90%	183x64x19mm	Aluminio	IP67	Medida de los Cables 16cm c/u
WEL-007	Fuente de Poder CD 12V a 16.7A Aluminio Impermeable	200W	90-140V~50/60Hz	12V==	90%	181x103x50mm	Aluminio Impermeable	IP63	A Prueba de Lluvias
WEL-008	Fuente de Poder CD 12V a 29.16A Aluminio Impermeable	350W	90-140V~50/60Hz	12V==	90%	181x103x50mm	Aluminio Impermeable	IP63	A Prueba de Lluvias
WEL-011	Fuente de Poder CD 24V a 4.17A Aluminio Interior	100W	110-277V~50/60Hz	24V==	90%	145x48x30mm	Aluminio	IP20	Compatible con WTI-013/014/015

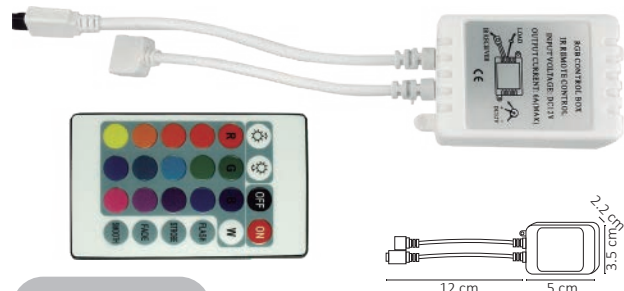

WAC-001

72W



WAC-002

72W

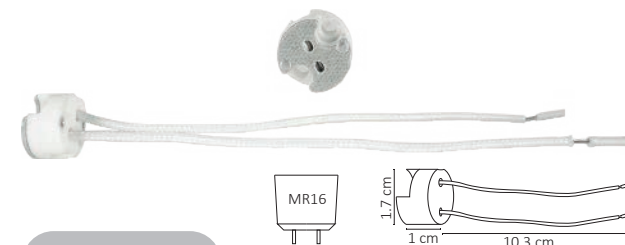

WAC-005

100W

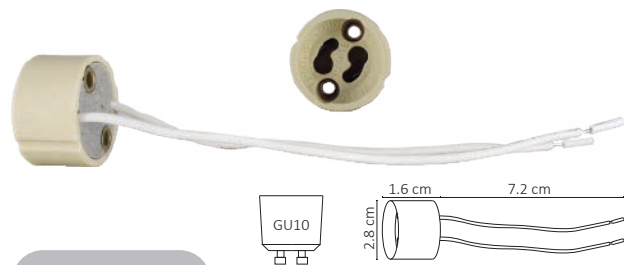

WAC-006

100W



WAC-007

100W



WAC-012

100W

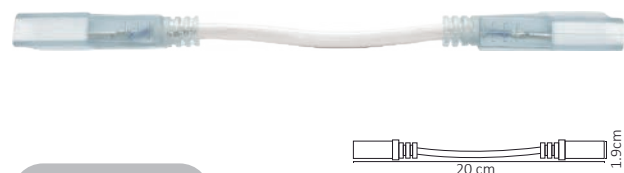

WAC-013

100W

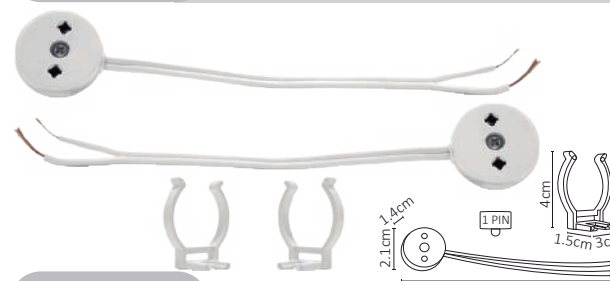

WAC-014

100W

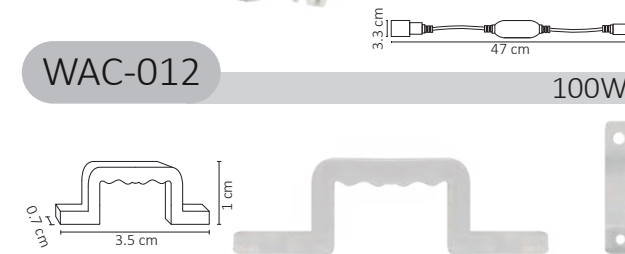

WAC-015

#	💡	Ⓜ	⚡	☀️	360°	🌈	📏	💎	💧	🔍
Código	Producto	Watts	Voltaje	Lúmenes	Apertura	Temp. Color	Dimensiones	Material	Protección	Observaciones
WAC-001	Controlador Tira RGB con Control de 16 Colores	72W	12V==	-	-	-	50x35x22mm	Plástico	IP20	Incluye Control con Batería
WAC-002	Amplificador Tira RGB Slim Interior	72W	12V==	-	-	-	162x13mm	Plástico	IP20	Amplificador
WAC-005	Conector Base MR16 Plástico con Cable	100W	90-260V~50/60Hz	-	-	-	17x10mm	Cerámica	IP20	Medida del Cable: 10.3cm
WAC-006	Conector Base GU10 Cerámica con Cable	100W	90-260V~50/60Hz	-	-	-	28x16mm	Cerámica	IP20	Medida del Cable: 7.2cm
WAC-007	Conector Base G13 para Tubo T8	100W	90-260V~50/60Hz	-	-	-	38x38mm	Plástico	IP20	Base para Tubo G13
WAC-012	Conector Simple Kit para 50M Manguera 2835 CA 127V Exterior	Max. 200W	127V~50/60Hz	-	-	-	470x33mm	Plástico	IP65	Para Conectar Manguera 127V
WAC-013	Conector Extensión Manguera 2835 20cm Exterior	100W	127V~50/60Hz	-	-	-	200x19mm	Plástico	IP65	Para Interconectar 2 Mangueras
WAC-014	Kit de Conexión de Tubo LED	100W	90-260V~50/60Hz	-	-	-	170x21x14mm	Plástico	IP20	Para Tubo T8 de 1 PIN
WAC-015	Clip de Plástico para Fijación de Manguera	Máx. 100W	-	-	-	-	35x10x7mm	Plástico	IP65	Kit de 10 Piezas



WAC-016

500W

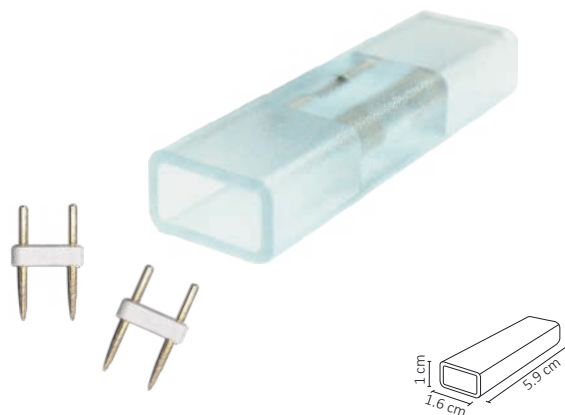

WAC-017

100W

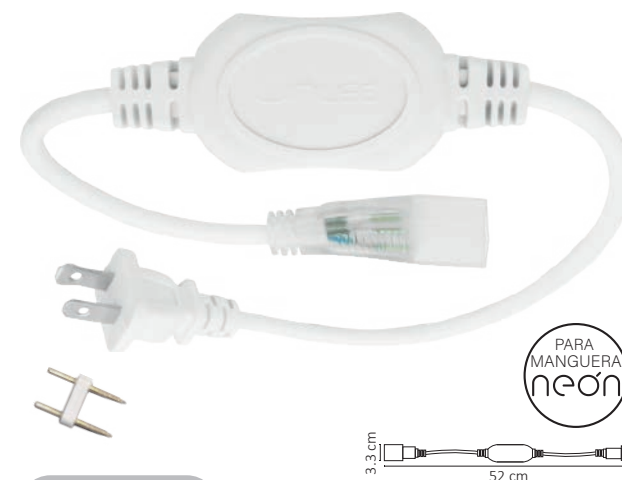

WAC-018

150W

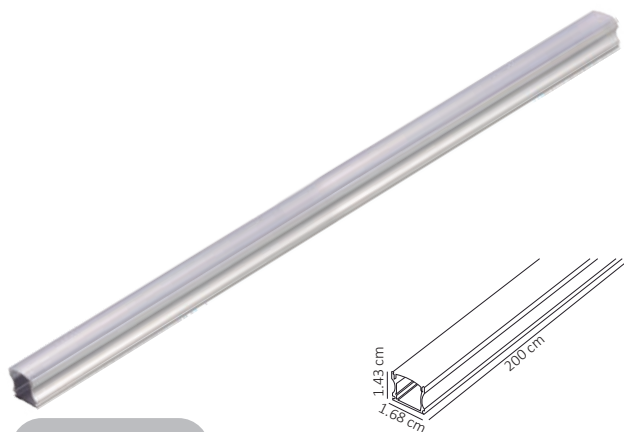

WAC-019

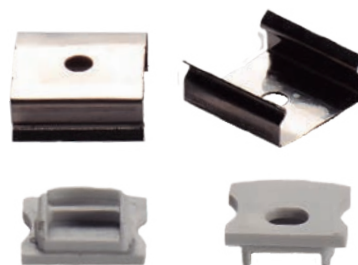

WAC-020

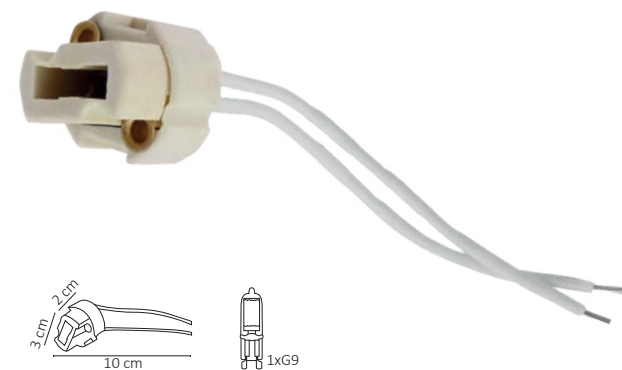
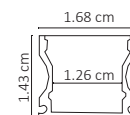

WAC-021

Máx. 50W

#	💡	W	⚡	☀️	360°	🌈	↔️	💎	💧	🔍
Código	Producto	Watts	Voltaje	Lúmenes	Apertura	Temp. Color	Dimensiones	Material	Protección	Observaciones
WAC-016	Atenuador RF para Manguera LED con Control	Máx. 500W	127V~50/60Hz	-	-	-	95x25x67mm	Aluminio	IP20	Med. Cable: 25.5cm y 16.6cm
WAC-017	Conector Medio para Manguera LED	Máx. 100W	127V~50/60Hz	-	-	-	16x59x10mm	Plástico + Pin de Metal	IP65	Incluye 2 Pines
WAC-018	Conector Simple para Manguera Neón	Máx. 300W	127V~50/60Hz	-	-	-	520x33mm	Plástico	IP65	Para Manguera Neón
WAC-019	Perfil de Aluminio Anodizado con Cubierta PC Opalina para Tira LED	-	-	-	-	-	2000x143x168mm	Aluminio + PC	IP20	Perfil para: WTI-013/014/015
WAC-020	Kit de Instalación Perfil Aluminio para Tira LED	-	-	-	-	-	16.8x14.3mm	Lámina y Plástico	IP20	Accesorio para WAC-019 2 Tapones y 2 Grapas
WAC-021	Conector G9	Máx. 50W	90-260V~50/60Hz	-	-	-	100x20x30mm	Cerámica	IP20	Cable 14cm



WAD-001 Máx. 50W WAD-002 Máx. 50W WAD-003 Máx. 50W

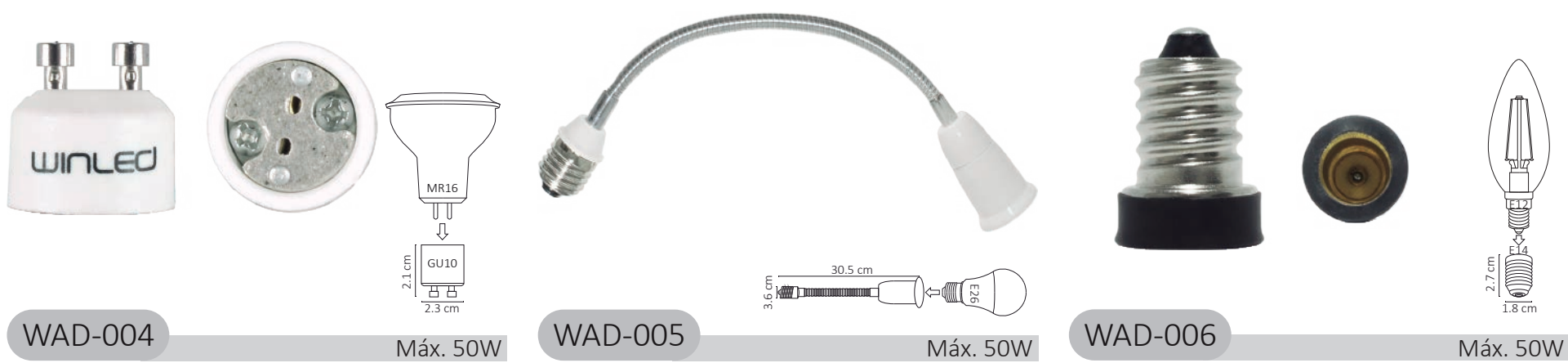

WAD-004 Máx. 50W WAD-005 Máx. 50W WAD-006 Máx. 50W

#	💡	Ⓜ	⚡	☀️	360°	🌈	📏	💎	💧	🔍
Código	Producto	Watts	Voltaje	Lúmenes	Apertura	Temp. Color	Dimensiones	Material	Protección	Observaciones
WAD-001	Adaptador de Base E26 a Lámpara E12	Max. 50W	90-300V~50/60Hz	-	-	-	29x26mm	Lámina + Plástico	IP20	E26 a E12
WAD-002	Adaptador de Base E26 a Lámpara GU10	Máx. 50W	90-300V~50/60Hz	-	-	-	35x50mm	Lámina + Cerámica	IP20	E26 a GU10
WAD-003	Adaptador de Base E40 a Lámpara E26	Máx. 50W	90-300V~50/60Hz	-	-	-	45x50mm	Lámina + Plástico	IP20	E40 a E26
WAD-004	Adaptador de Base GU10 a Lámpara MR16	Máx. 50W	90-300V~50/60Hz	-	-	-	23x21mm	Lámina + Cerámica	IP20	GU10 a MR16
WAD-005	Adaptador Extensión Flexible 30cm de Base E26 a Lámpara E26	Máx. 50W	90-300V~50/60Hz	-	-	-	305x36mm	Lámina + Plástico	IP20	Extensión 30cm E26 a E26
WAD-006	Adaptador de Base E14 a Lámpara E12	Máx. 50W	90-300V~50/60Hz	-	-	-	18x27mm	Lámina + Plástico	IP20	E14 a E12

CATÁLOGO 2022

I l u m i n a c i ó n L E D



NOM-001-SCFI-1993
NOM-003-SCFI-2014
NOM-030-ENER-2016
NOM-031-ENER-2012



ar7lite
ILUMINACIÓN LED

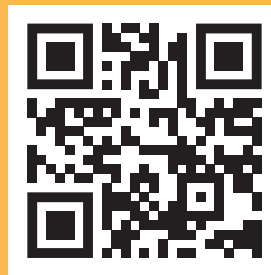

www.innlite.com



WINLED
Más que Iluminación

Grupo INNLITE, te informa que nuestros productos se encuentran certificados bajo la **NORMA OFICIAL MEXICANA**. Cada familia de producto, requiere una o varias NOM en específico, la cual **Grupo INNLITE**, puede brindarte a solicitud expresa.

¿Porque comprar productos certificados? El certificado de cada producto, garantiza que nuestros productos cumplen con los criterios de Calidad, Seguridad, Eficiencia y Correcto Funcionamiento, que demanda el gobierno federal, a través de sus dependencias competentes.

Cuando utilizas Producto **AR7LITE** o **WINLED**, estas garantizando la satisfacción de tu cliente o proyecto.